

Energy-storage concrete

THERMAL COMPONENT ACTIVATION

Energy-storage concrete

Thermal component activation

Planning guide

Single family and terraced houses

Felix Friembichler | Simon Handler | Klaus Kreč | Harald Kuster

Building of Tomorrow

Continuous research and development has made Austria a world leader in the field of building and energy-efficient technology.

That is why I am very proud that the "Building of Tomorrow" research and technology program as well as its successor, "City of the Future" from my portfolio are among the most successful areas of funding in all of Europe - they have made a big contribution to Austria becoming one of the leading nations in this field.



Mag. Jörg Leichtfried
Federal Minister for Transport,
Innovation and Technology

© bmvit/Johannes Zinner

A handwritten signature in blue ink, appearing to read 'Jörg Leichtfried', written on a white background.

We live in a time characterised by a steady increase in urban life. The future of our children will be even more urban. On a global scale, every week one million people move from the country to the city. Extrapolated to a whole year, this makes up the population of eight cities the size of New York. It is therefore crucial that urban centres produce and consume the cleanest energy possible.

In the future, cities should be more sustainably structured; urban sprawl will make way for densification. They will budget their energy better, for example by generating their own energy in a sustainable manner. This trend is becoming an increasing part of the paradigm of city planning, for example in the form of façade-integrated solar panels, passive house building methods and PV modules for buildings.

Another option is to view the city as an energy sponge. That means using cities as a type of battery for storing energy for long periods of time. With its research and technology programs, Austria has already done significant preliminary work and is one of the pioneers in this field. In the framework of the "Building of Tomorrow" program, successful projects have been completed concerning the research issue "Heating and Cooling with Concrete" (thermal component activation).

This planning guide summarises the findings of these research projects and shows in detail how energy is stored in massive structures over long periods of time and can be retrieved at any time. This innovation is very economic and energy efficient. Although it has only been applied in small and demonstration buildings so far, it takes important steps in the right direction needed to organise the energy supply for whole neighbourhoods in an environmentally-friendly way in the future. With this exceptional achievement, we have surely come closer to the goal of designing, planning and building more sustainable cities.

An idea as simple as it is brilliant

The thermal optimisation of buildings demanded by an increasing number of customers requires the development and implementation of adequate measures in the technical building equipment sector.



Baurat h.c. Bmst.
Dipl. Ing. Felix Friembichler
Project Manager



A very effective approach to increasing the energy efficiency of buildings is the intelligent use of load-bearing components made of concrete for storing thermal energy. Pipe systems are introduced into large-scale components made of concrete such as storey ceilings to transport a heat carrier, which can be used to control the temperature in adjacent rooms. In the building industry, this system is known as "thermal component activation" (TCA).

The integration of the energy benefits of highly-insulated buildings with the possibility of thermal management of the supporting structure of buildings opens a new dimension of energy-efficient construction. One of the outstanding benefits of TCA is the level of thermal comfort ensured inside the building throughout the entire year. Of course, this aspect of high energy efficiency, positive for the quality of living and very conducive for the health of the occupants, is linked to the optimal use of the potential of renewable energy as well as easy, cost-effective building technology systems.

With this planning guide, thermal component activation is made accessible in an easy and comprehensible manner to a wide circle of interested parties. The content of the planning guide is designed for the needs of planners and builders as well as for the transfer of knowledge in trainings and continuing education.

The planning guide handles questions of building physics, the design of buildings, associated building technology and its regulation as well as energy supply considerations. A good amount of space is devoted to the calculation of the components of TCA. In order to illustrate the theoretical treatises, an accurate interpretation of TCA for a newly-built single-family house is broken down into steps as a conclusion to this report.

Encouraged by the positive experiences of building single-family and terrace houses, we believe the next step is to initiate the use of TCA in large-scale residential buildings. The benefits of TCA already noted are joined by interesting possibilities for transport and storing heat in metropolitan areas.

Contents



Page	
2	Preface Building of Tomorrow Minister Magister Jörg Leichtfried
4	Preface An idea as simple as it is brilliant Baurat h.c. Bmst.Dipl. Ing. Felix Friembichler
6	Contents
8	Facts
22	Prerequisites
32	Energy supply
33	Development of an energy concept
38	The building as energy storage
40	Component activation as heat output and heat extraction system
42	Active and passive cooling
44	System variants
45	Variant 1: Energy supply via solar thermal energy
49	Variant 2: Energy supply via photovoltaics and heat pump
53	Variant 3: Energy supply via wind energy and heat pump
56	System control

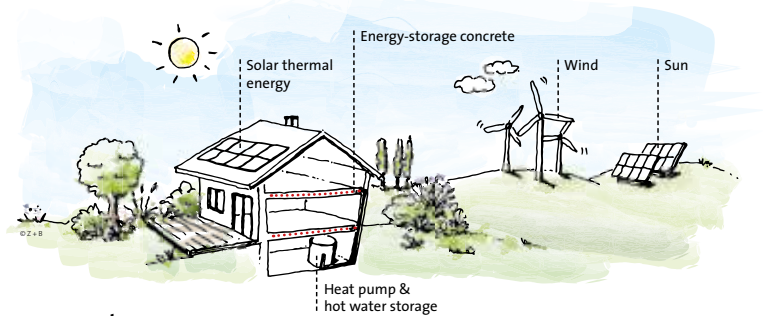



Application examples of thermal component activation: Assembly of pipelines, pressure test and placing of concrete for the ceiling.
© Aichinger Hoch- u. Tiefbau GmbH

Page	
66	Basis for planning
67	Calculation of heat load of considered space
69	Calculation for heat load of a model room
71	Calculation for heat load according to the PHPP
74	Calculation of the effective heat exchanger surface
79	Requirements on the building envelope
83	Positioning of the pipe register
84	Structure of the thermally-activated ceiling
86	Application example
96	Calculation example
101	Calculation for heat load according to the PHPP for the entire house
107	Calculation for heat load according to the PHPP for the combined kitchen/living room
111	Design of the effective heat exchanger surface
113	List of figures & tables / Bibliography
113	List of figures
117	List of tables
117	Bibliography
118	Legal information



3D representation of the model room © Z + B



Rendering of the calculation example
© Aichinger Hoch- u. Tiefbau GmbH

Facts

This planning guide provides information on the option of solely heating and cooling small-volume residential buildings by means of **thermal component activation (TCA)**.

Concrete instructions on the planning of residential buildings with thermally-activated ceilings are also provided.



Fig. 1 | During component activation, a system of water-conducting pipelines is laid into concrete components. This is perfectly easy to accomplish. © Aichinger Hoch- u. Tiefbau GmbH

Thermal component activation

An important property of TCA is that it is used not only for heating, but also for cooling. The possibility of cooling has already proven to be a valuable and, in many cases, necessary contribution for ensuring high thermal comfort throughout the entire year, even for residential buildings. In light of the current climate change, the importance of this topic will increase significantly in the near future. The year-round temperature control of residential buildings by means of TCA can therefore be classified as an essential part of planning approaches in relation to forward-thinking construction.

TCA enables forward-thinking construction. <<

TCA denotes systems for heating and cooling rooms or entire buildings whose distinctive feature is that the heating and cooling registers are set in concrete components while the building is being constructed. Due to the typically very high effective heat exchanger surface, such heating and cooling systems are classified as "surface heating".

Since the heat output of a radiator is nearly proportional to the radiator surface when the temperature of the heating medium is kept uniform, with surface heating, the necessary heat output can be achieved with temperatures of the heating medium which are only slightly above the set temperature of the room to be heated.

Component activation therefore represents a special type of surface heating, as the heating register is encased and surrounded by concrete - a material with very good heat-conducting properties and heat capacity.

Concrete as energy storage

The good thermal conductivity of concrete ensures that heat can penetrate from the pipe register into the thermally-activated ceiling without great resistance and therefore quickly. The very good heat capacity of concrete also means that relatively large amounts of heat can be fed into the "radiator" - the thermally-activated concrete ceiling - without having to increase the temperature much. This is of great importance for TCA, as thermal comfort in the heated room is significantly affected by the temperatures of the surfaces facing the room. Greatly varying surface temperatures, such as those that inevitably occur with conventional radiators with flow temperatures of and over 50 °C, have a negative effect on the comfort in the room. On the other hand, large, moderately heated surfaces, such as thermally-activated ceilings, ensure nearly uniform inner surface temperatures of the space-defining components and therefore guarantee the best thermal comfort.

TCA ensures high thermal comfort. >>

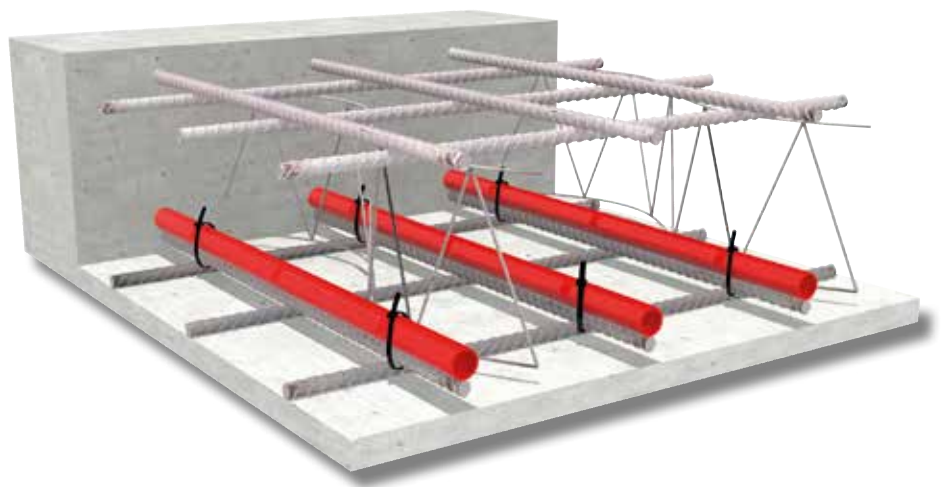

Fig. 2 | Schematic diagram of component activation of a storey ceiling. © Z+B

The heat capacity of a building depends on its thermal conductivity, specific thermal capacity and mass density in addition to the component thickness. Special features of concrete relevant here are its mass density and very good thermal conductivity. Due to the very high mass density, concrete is a very good heat accumulator. The good thermal conductivity ensures that heat can fairly quickly penetrate its accumulator.

In contrast to concrete, for example solid wood has a very high specific thermal capacity, but much lower mass density. A wall made of solid wood would be roughly equally effective as a heat accumulator as a concrete wall of the same thickness. However, the main difference is that the thermal conductivity of concrete at $\lambda = 2.0 \text{ Wm}^{-1}\text{K}^{-1}$ is a magnitude higher than that of wood ($\lambda = 0.13 \text{ Wm}^{-1}\text{K}^{-1}$). In order to penetrate into the building construction or to conduct away from it, heat therefore needs a much longer time through solid wood than concrete or reinforced concrete. Components with high heat capacity and good thermal conductivity reduce temperature fluctuations in a room. They dampen daily fluctuations in the room temperature and prevent short-term temperature peaks.

The heat capacity of building constructions made of concrete

Concrete components very effectively prevent temperature peaks. <<

Thermal activation of ceilings has been used successfully for a long time, primarily in office buildings, to conduct away excessive heat for cooling purposes. The planning instructions in this guide are devoted to the topic of how this proven system can be used not only for cooling, but also for heating buildings. For the time being, the focus is on small-scale residential buildings.

The ceiling as a thermally-active building element for heating and cooling

It is evident that it is beneficial to use one and the same system for heating and cooling. However, the question is if the potential of TCA for cooling is even needed for residential buildings. The standards to be upheld require pleasant indoor climatic conditions in residential buildings without cooling, even during summer hot spells. However, we must look critically at the question of whether this requirement can be complied with in reality. In any case, the explosive increase in the sale of cooling appliances is an argument against this.

Table 1 | Growth of power consumption for air conditioners and fans in Vienna
(Source: EEG calculations (TU Wien); Energy Report of the City of Vienna 2014)

(GWh/a)	2000	2005	2010	2011	2012
Private air conditioning systems	0.0	19.0	27.0	27.9	28.1
Private fans	3.8	7.4	11.5	11.9	11.9
Private total	3.8	26.4	38.5	39.8	40.0



Fig. 3 | The installation of heating and cooling registers into the ceiling can be done quickly, easily and therefore economically. © Aichinger Hoch- u. Tiefbau GmbH

Future-oriented planning and building with thermal component activation

Since, from today's perspective, it is not foreseeable that the current climate change can be stopped or even slowed down, those active in the building and house technology planning industry must seriously and deliberately deal with the outdoor climatic conditions expected in the near future; this also goes for those working in other sectors such as agriculture and forestry, water and energy supply, tourism, etc. In light of this, TCA is taking root as a system which can heat and cool and is an important element of forward-thinking planning and building.

The thermal activation of storey ceilings opens up benefits concerning both construction and building physics, which must be purposely utilised. From a constructional point of view, we have seen that the installation of heating and cooling registers into the ceiling can be done quickly, easily and therefore economically. From a building physics standpoint, it is essential that the thermally-activated surfaces border the rooms to be heated/cooled as freely as possible and are not shielded by thermally-insulating layers. This is easy to do with ceilings. With thermal activation of storey ceilings for the purpose of heating or cooling of floors, however, this requirement can typically only be fulfilled by accepting a decline in the effectiveness of the temperature control system. Thermal activation of ceilings is also advantageous in comparison to wall heaters: Installation of the pipe register is much easier. In addition, the danger of hitting the pipe register when drilling dowel holes for mounting brackets is nearly non-existent. Moreover, the considerations regarding the reliability of interior design solutions become superfluous.

Storey ceilings are very well-suited for the use of TCA. >>

The thermal activation of storey ceilings, despite hasty judgements against it, is a very good method for heating and cooling rooms. The reason for prejudices against ceiling heater is the idea that heat rises. An analysis of this argument makes it necessary to specify something: Of course hot air rises. However, a very important characteristic of large-volume heat output systems is that, due to the relatively low surface temperatures of the heated areas, the convective share of the heat transfer is minuscule. Surface heating therefore functions almost totally as a radiant heating system. Heat radiation is massless; it is therefore completely independent of gravity and does not know the difference between "up" and "down". The ceiling soffit as a low temperature-controlled heating area is in principle not a problem. Thanks to the many years of experience with these types of systems, primarily in office buildings, we know that the ceiling area is also very well-suited for cooling.

Large-volume heating systems function almost totally as radiant heating systems

Heat radiation does not differentiate between "up" or "down". <<

The special feature of heat transport based on long-wave radiation ("heat radiation") is that a transmission medium is not required for transport. Every body radiates heat at all times and also absorbs heat from other sources of radiation. On the one hand, the intensity of the heat radiation depends on the surface properties of the body and, on the other, on the temperature of the surface. The higher the temperature of a surface, the larger its heat emission. If, with TCA, warm, thermally-activated surfaces face cooler, unheated surfaces, the radiant heat transfer between the two surfaces also involves heat transport. Both surfaces radiate heat, but the activated surface does so with higher intensity.

Heat transport through heat radiation

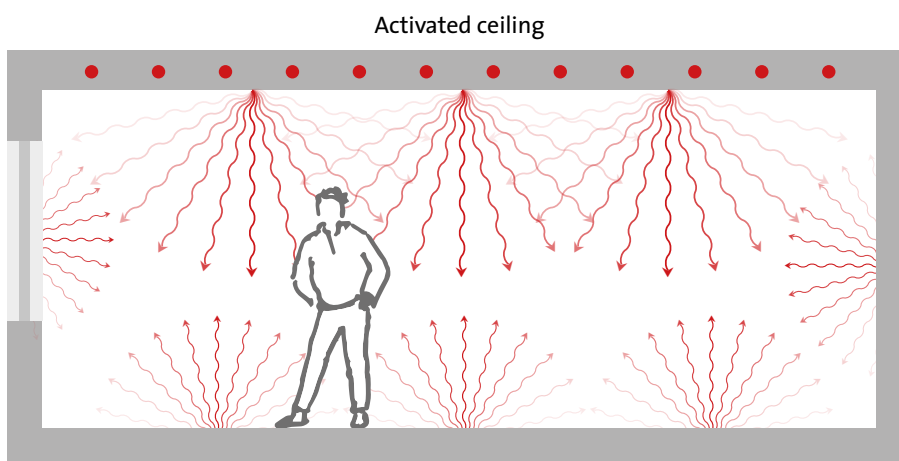

Fig. 4 | Schematic diagram of heat radiation: Every point of the activated ceiling (and also of the other components enveloping the room) radiates heat in a semispherical shape, just as is shown using the randomly selected points in the graphic. © Z+B

Positioning effective heat exchanger surfaces with good "visual contact" to cool surfaces. >>

Overall, heat transport occurs from the warm, activated surfaces to the cooler, unheated surfaces. The unheated surfaces are warmed up. Radiant heat transfer therefore has a balancing effect on the surface temperatures of the room-adjacent components. It is particularly effective if both temperature-controlled surfaces can "see" each other well. For a thermally-activated ceiling, this is true especially for the floor. The oft-expressed fear that the floor will remain cold with a heated ceiling proves to be unfounded.

Very low temperature differences in rooms with TCA

It is possible to mathematically quantify the radiant heat transfer in the room. The calculation result can be visualized by drawing isotherms - lines of the same temperature - for vertical or horizontal sections leading through the room. It has been shown that the temperature differences are quite small both for vertical and for horizontal sections through the room - in the magnitude of 1 K (see Fig. 5).

Heat radiation spreads in a straight line in all directions from every point in the room. The weakening of the irradiation intensity when passing through the air in interior areas of a building is negligibly small. The distances between the heated and unheated areas of a room do not play a role in this regard. So, for example, the radiant heat transfer between heated ceilings and floors continues unimpeded when the room height is increased. In this context, it must be noted that, in such a case, the percentage of heat radiation coming from the ceiling which hits the floor becomes successively smaller. By contrast, the percentage which hits the wall surfaces increases to the same degree.

This amazing calculation result has since been substantiated by practical experience. >>

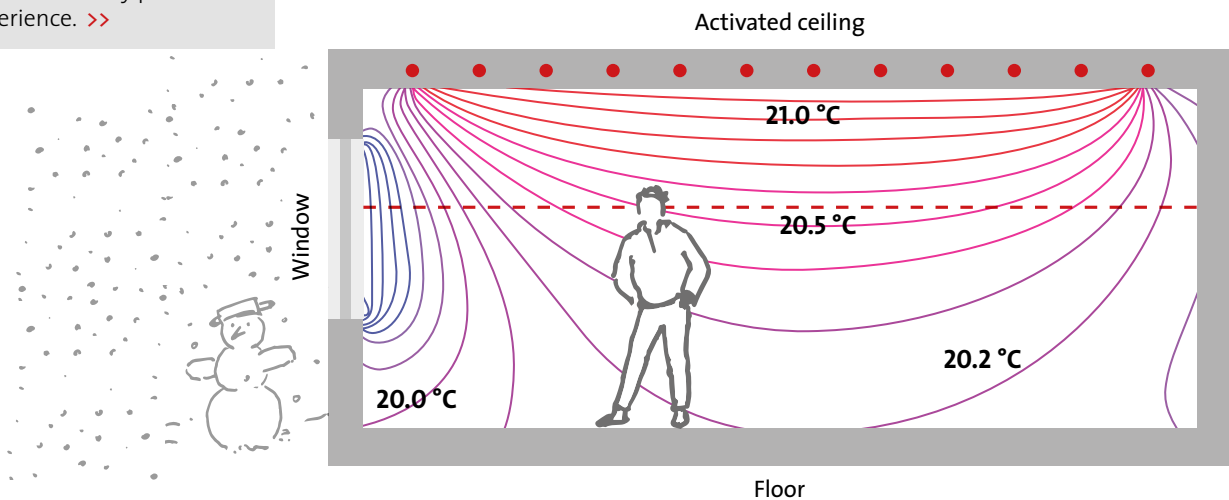
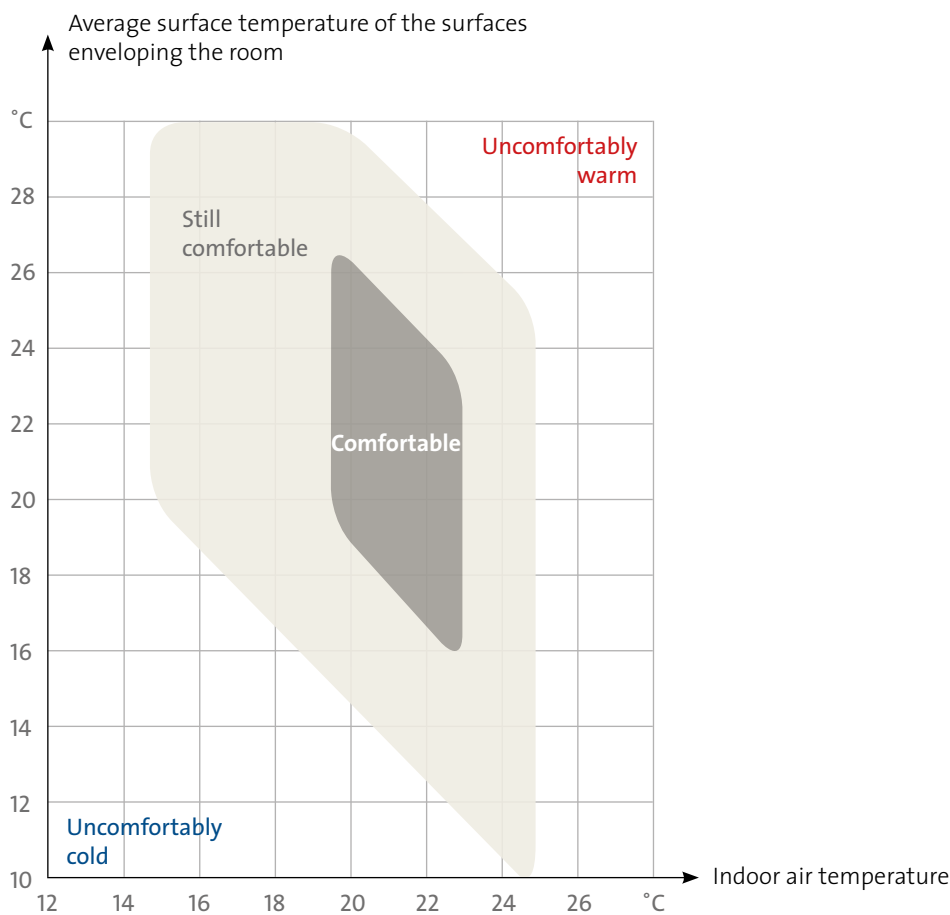

Fig. 5 | Vertical section through a model room with isotherms during heating/winter operation with an activated ceiling. Noticeable is the uniform temperature distribution and the small temperature differences in the room. © Z+B

The uniform surface temperatures in a room heated or cooled by TCA ensures very good thermal comfort. Due to the absence of convective exchange with a large-scale heater, the distribution of dust and harmful substances is prevented. This means that the health value of a room conditioned with TCA is to be classified much higher than that of a conventionally heated room.

High health value of rooms with thermal component activation

One of the special features of component activation is that, in highly insulated buildings, the surface temperature of the heated parts of the ceiling soffit is only a bit above the set temperature of the room, even under adverse outdoor climatic conditions. This surface temperature should exceed the set temperature of the room by no more than 4 K under design conditions, meaning in the event of extreme outdoor climatic conditions.



The goal is a Δ (Delta) of maximum 4 K between surface and room temperatures in the centre of the comfortable area. <<

Fig. 6 | Comfort range of surface temperature to air temperature. © Z+B
 Source: www.thermische-behaglichkeit.de/thermische-behaglichkeit.
 The comfort criteria are easy to uphold with TCA.

The primary reason for this upper limit are considerations for ensuring high thermal comfort in the room. Thus, large temperature differences both between heated and unheated surfaces are to be avoided between the surfaces and the room air.

The minor differences between the set temperature and the surface temperature of the thermally-activated ceiling prove to be responsible for the so-called "self-regulating effect" of thermally-activated components. The smaller the differences between the set and the surface temperature, the lower the heat output or, when it comes to cooling, heat absorption of the thermally-activated component. The elimination of complex regulation strategies helps to design simple building technology for heating and cooling, thereby ensuring high thermal comfort without the user having to continuously take action.

Self-regulating effect of TCA

TCA balances out the temperature between all surfaces and the room air independently and at all times. >>

The values of the surface temperature of the thermally-activated parts of the ceiling soffit just over the set temperature for heating or just below the set temperature for cooling are the reason for another characteristic property of component activation. The heat output or absorption of the activated ceiling is, in a first approximation, proportional to the difference between the room temperature and the surface temperature. If the room air temperature and/or the inner surface temperatures now rise, the heat output of the thermally-activated ceiling drops during heating. The corresponding behaviour of course also applies for cooling. In the borderline case that the surface temperature of the heated or cooled ceiling soffit matches that of the non-activated inner surfaces and the room air temperature, the activated ceiling does not output any more heat during heating operation. During cooling operation, it correspondingly does not absorb any more heat.

The self-regulating effect allows for significant simplifications in regulating TCA. >>

This "self-regulating effect" only occurs with heating and cooling systems which work with very low temperatures of the heating medium and comparatively high temperatures of the cooling medium. With a common radiator, the surface temperatures under design conditions are typically over 35 °C. When increasing the room temperature above e.g. 24 °C, the flow through the radiator must be slowed down to reduce the heat output of the radiator. If, however, the surface temperature of a thermally-activated ceiling is 24 °C, the ceiling does not output any more heat at 24 °C, regardless of the flow speed of the heating medium in the pipe register. Regarding heat regulation, the self-regulating effect results in significant simplification even concerning the building technology.

In the case of heating, the relatively low surface temperatures can be ensured even at unusually low temperatures of the heating medium. The flow temperatures range just over 30 °C even under the worst outdoor climatic conditions. According to what has already been said, these low temperatures of heating medium during TCA are not only possible, but are even a necessary prerequisite for good functioning of the heating system and for high thermal comfort in the room. This makes possible more effective use of renewable energy. In addition to the combination of TCA with thermal solar collectors, in particular heat supply via heat pumps, which are predominantly operated using electricity from wind power plants or photovoltaic systems, must be named here.

Very low temperatures of the heating medium

Low temperatures of the heating medium ensure economic operation. <<

The use of electricity to generate heat (also) when using heat pumps has been avoided for a long time due to the argument that electricity is too valuable as a form of energy. With heat pumps, this argument must be critically analysed insofar as the performance factors of heat pumps are in the range of four to at least three. This means that the use of a kilowatt hour of electricity results in about four, but at least three, kilowatt hours of heat. The heat is drawn from the environment, whereby heat generation is usually achieved (in about 60% of cases) through the air (air-water-heat pump). Heat recovery through the soil or groundwater is therefore an interesting alternative, since the heat pump can be operated much more efficiently in this case. The primary circuit of the heat pump consists of pipe registers laid horizontally in the soil at low depths (1.0 to 2.0 m) or of pipes which enable the withdrawal of heat from layers deep below the surface of the earth through deep drilling (coordinated to the soil conditions and the heat load of the building down to depths of 150 m).

TCA as the ideal application for renewable energy

With the energy revolution, there are currently other arguments concerning a purely electric solution for heat generation. Electricity accrues in very irregular intervals with both wind power and photovoltaic systems. The question of effective options for the storage of electricity surpluses is already being asked. With the increasing changeover to the use of renewable energy, this question is becoming increasingly important. TCA is an interesting approach, as storing heat in thermally-activated concrete ceilings is possible without noticeably influencing the thermal comfort in rooms. In this light, heat generation via heat pumps is very significant.

Linking renewable energy - TCA - heat pumps enables forward-thinking solutions. <<

With respect to heat generation through solar collectors, TCA also proves to be a very well-suited heat distribution system for buildings. The short-term and irregular supply of heat, particularly in winter, can be temporarily stored in the building ceilings by means of through-flow through the pipe register and is output to the inside spaces with a time delay in compliance with the comfort requirements.



Fig. 7 | Renewable energy, such as wind power (© W.E.B-Windkraftanlage/eric krügl) and solar power through a photovoltaic system (© F. Huber) or a thermal solar plant (© GASOKOL) are predestined for use by means of TCA.

The temperature of the heating medium, however, will considerably exceed the named upper limit of just over 30 °C in the event of high sun radiation, even in the middle of winter. Short-term temperatures of the heating medium of up to about 45 °C are permitted for efficient use of the accruing energy. The pumping in of this actually excessively hot heating medium into the pipe register is not a problem if the time interval of this high heat input is limited to a few hours - a circumstance that is almost always given in the middle of winter. The high heat capacity of the concrete also ensure that the high heat input only slowly warms up the concrete ceiling. Losses regarding the thermal comfort in the room are also not to be expected in this case.

Concrete balances out temperature peaks when storing heat. <<

In inter-city areas, the supply of buildings with district heating is also an issue. For TCA, district heating seems to be disqualified at first glance since the heat is delivered at a temperature level that is much too high. If transfer stations are equipped with mixer controls, low temperature operation is possible. This solution is attractive to district heating operators because the time intervals outside of the peak loads can be used for heat delivery. Another interesting approach for increasing efficiency of the use of district heating is installing a secondary circuit for supplying the buildings or groups of buildings and connecting this to an existing district heating network.

In addition to the high heat capacity of concrete, TCA also provides an additional potential which is becoming increasingly important with the use of renewable energy. Renewable energy, such as that created by the use of wind (windmills) or sun (photovoltaics) in the form of electricity or from thermal solar energy systems in the form of energy supplied from heat are not available at all times, but at irregular time intervals that are difficult to accurately predict. The energy rev-

Use of renewable energy

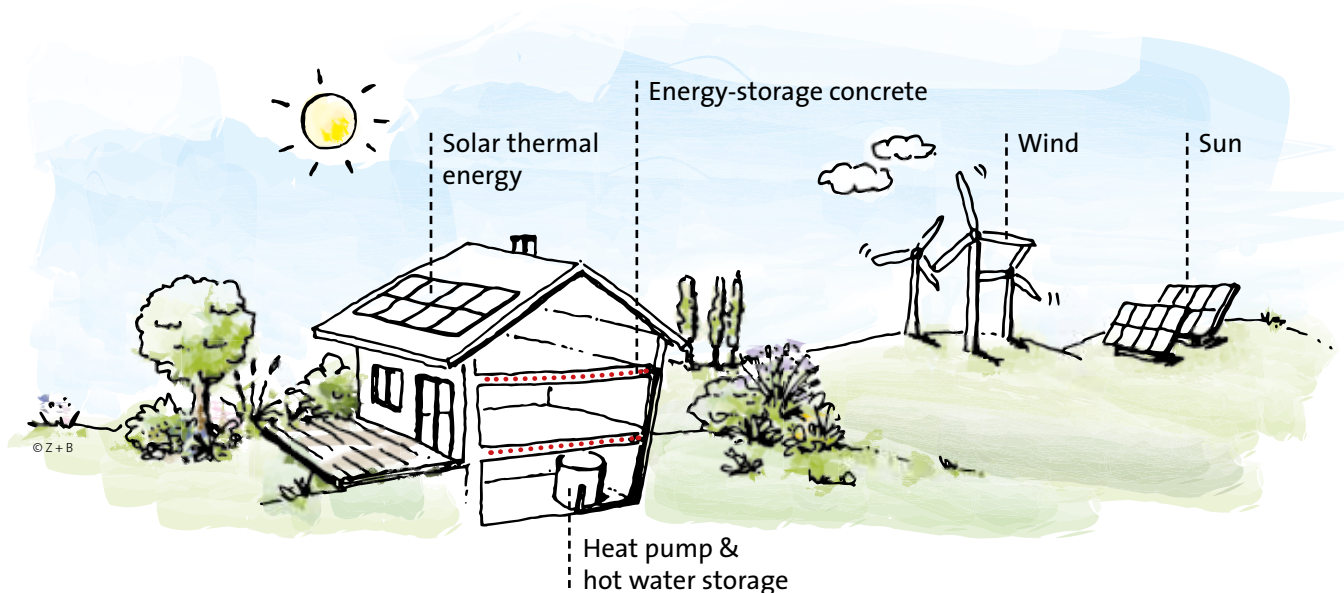

olution, i.e. the switch to the sole use of renewable energy, is closely linked to the question of the effective storage of energy for this reason. In this case, TCA represents a special type of highly-efficient energy storage. The charging of the storage medium - e.g. the thermally-activated ceiling - can also be done at irregular intervals without disturbing the thermal comfort in the rooms to be heated. Energy is temporarily stored in reinforced concrete ceilings in the form of heat.

The requirement in EU guideline 2010/31/EU for maximum utilisation of renewable energy to cover the heating demands of buildings is very easy to fulfil using TCA.

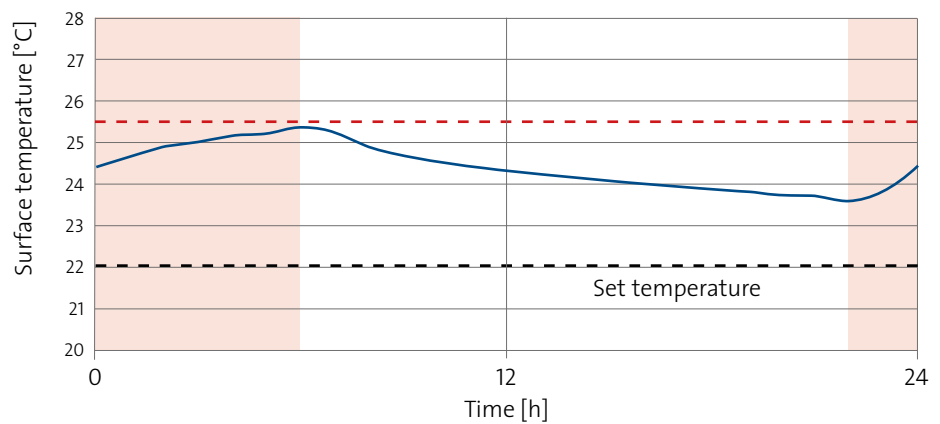

Fig. 8 | Calculated in the course of a day, the average surface temperature at the ceiling soffit for heat supply restricted between 10⁰⁰ pm and 6⁰⁰ am (use of off-peak electricity); set temperature of the room: 22 °C. © Klaus Kreč

TCA as effective strategy for smoothing out peak loads

With a sufficiently high number of buildings with thermally-activated components, the adoption of peak currents from renewable energy help to smooth out supply peaks and, conversely, to minimise the need for electricity at the time when supply is low. In comparison to other types of energy storage, TCA is special in that the heat losses of the storage medium are not minimised, but rather used for ensuring thermal comfort in the building.

Energy-efficient cooling of residential buildings

The possibility of energy-efficient cooling of residential buildings makes TCA an innovative, forward-thinking planning approach. Similar to the case of heating, the large activated surfaces ensure that high cooling loads can be achieved at comparatively high temperatures of the cooling medium. Already at temperatures of the cooling medium of or over 20 °C, heating tendencies can be effectively intercepted during high summer hot spells. Ideally, only the energy for the use of the circulation pump affects cooling by means of TCA.

Since in the event that the activated ceiling absorbs heat - meaning in case of cooling - the high heat capacity of concrete has the effect that large amounts of heat can be absorbed without greatly increasing the temperature of the ceiling, the function of TCA in the summer is available even with non-continuous cooling operation. That is why renewable energy can be well-utilised in the case of cooling as well.

The same applies for heating and cooling: Environmental energies can be well utilised. <<

At relatively high temperatures of the cooled ceiling – these are not under 19 °C – the danger of condensation can be ruled out from the outset. Regarding the thermal comfort in the room, that said for heating remains unchanged: A very effective balance of surface temperatures occurs by means of radiant heat transfer, which directly results in high thermal comfort.

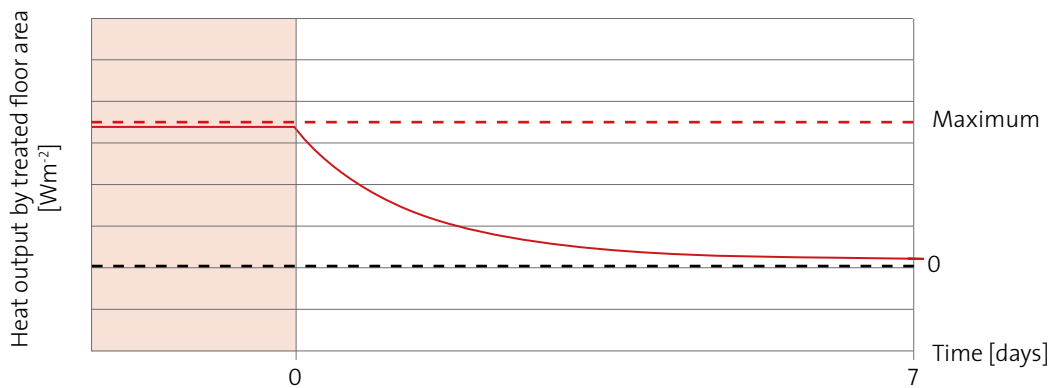

Fig. 9 | Absorption of the heat output by treated floor area of a thermally-activated ceiling after switching off the circulation pump. © Klaus Kreč

Pre- requisites

The heat output of a thermally-activated ceiling must not be increased arbitrarily. The upper limit for the heat load results from the requirement that the surface temperature of the heated ceiling parts must not be more than 4 Kelvin above the respective set temperature.

Prerequisite for TCA to function

The heating or cooling ("conditioning") of the rooms of a building by means of thermal activation of the storey ceilings alone is only possible if the heat load of the building is not too large. This restriction is based on the fact that the heat output of a thermally-activated ceiling cannot be arbitrarily increased. Based on the requirement of ensuring very high thermal comfort in the rooms, the surface temperature of the heated ceiling sections should not be more than 4.0 K over the respective set temperature in the room. Despite the typically very large sections available for activation, there is an upper limit for the heat load resulting from this requirement, which is relevant for new buildings or for parts of new buildings in individual cases (e.g. with very large window areas overall or in single rooms).

The reduction of the heat load is always connected with an improvement in the thermal quality of the building envelope. Through good thermal insulation, careful planning and implementation of component connections (prevention of "thermal bridges") as well as special consideration of the needs of an air-tight building envelope in planning and design, heat losses are effectively reduced by the building envelope. If a ventilation system with heat recovery is also installed, this usually leads to another rapid decrease in heat losses, which in turn considerably reduces the heat load.

An analysis of this problem shows that, with very well insulated buildings with ventilation systems and heat recovery, the ceiling surface available for activation is more than sufficient to cover the heat load and thereby also ensure the set temperatures even under extreme outdoor climatic conditions.

But even if the ventilation system is eliminated - so with ventilation heat losses not reduced by heat recovery - the thermal activation of storey ceilings can be a feasible option for reliable building conditioning. Very high thermal quality of the building envelope proves to be a basic requirement for the implementation of the concept of conditioning buildings by sole means of thermal activation of storey ceilings.

High-quality building envelope is the basic prerequisite for TCA

Effect of high-quality building envelopes on building use

Highly insulated buildings react even to small amounts of heat. >>

Sunny days and hot days require rethinking of the use of a building. >>

Buildings with very good insulation ensure uniform inside temperatures. >>

Building use has a significant influence both on the energy needs of a building and on the indoor climatic conditions to be set in the building interior. This applies for all types of buildings. In buildings with a high-quality envelope, the heat flow between the building interior and exterior is greatly reduced. This applies both in winter and in summer and results in the fact that both the ventilation heat losses and the heat sources occurring inside the building have much bigger effects on the thermal behaviour of the building than would be the case with buildings with lower-quality envelopes.

In low temperature buildings, even small amounts of heat are sufficient to keep the rooms at a pleasant temperature in winter. In summer, comparatively small amounts of indoor heat are enough to heat the rooms to high temperatures. In order to be able to deliberately limit heat input by sun radiation in the transition periods and in summer, planning the right window sizes and shade equipment adjusted to the windows takes on increasing importance. The building measures are an essential part of a high-quality building envelope.

Regarding utilisation, it must be emphasised here that the shading equipment only takes full effect when it is used correctly. Activating the shading equipment well before direct radiation occurs or using the shading equipment all day is therefore recommended on sunny summer days, for example.

In addition to restricting the solar radiant heat gain, ventilation plays a central role with regards to preventing overheating tendencies. In general, ventilation in summer above that required for hygiene is only practicable if the inside air temperature is higher than the outside air temperature. During hot spells, heavy ventilation should only be done at night and the building envelope should remain closed during the day.

If the building is used consciously and sensibly, the large cooling potential of the thermally-activated storey ceiling can be used wisely in summer and high thermal comfort can also be ensured during summer hot spells.

In general, the heating influences between the individual rooms of a building become more and more important though the reduction of the heat flow through the building envelope. For this reason, the distribution of the room temperatures is very balanced in buildings with high-quality envelopes.

The heating of a building by means of thermal activation becomes especially attractive when it is ensured that no heating is required in addition to component activation. In contrast to conventional building technology planning, decisions must be made regarding the selection of component activation in the early planning phases.

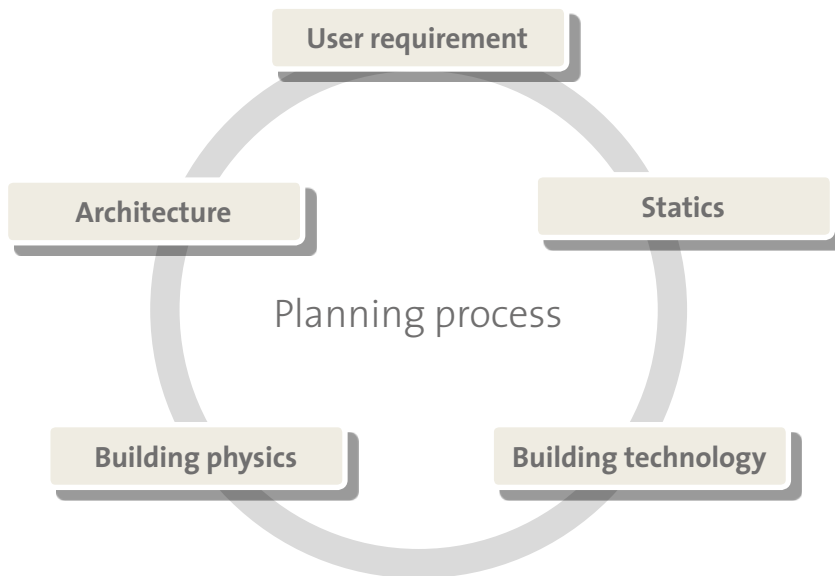

Planning across trades as early as the draft phase

Architecture, user requirements, statics, building technology and building physics work hand-in-hand in the planning process. <<

The reason for this is obvious: The decision for component activation not only affects the planning of building technology, but also the architectural design, dimensioning of the storey ceilings by the structural engineers and, if need be, the inspection of connection details by the building physicist as well as the determination of the necessary heat exchanger surfaces by the in-house technician.

This shows that, in addition to an early decision on the type of heat output or absorption in the rooms, healthy interdisciplinary cooperation is necessary. It would be a mistake to view this need as a burden to the planning process. On the contrary, integration of and good collaboration between specialist planners is an indispensable prerequisite for all kinds innovative building concepts.

Ideally, the building service planner, even before beginning the planning of the building concept, should investigate the essential local conditions for the use of TCA.

The decision about the type of heat output system in the rooms, or simply speaking, the type and size of the radiators, always requires a calculation for heat load for all rooms of the building. The decision for or against thermally-activated ceilings depends on the results of calculation for the heat load of considered space.

Currently valid standards do not include the calculation for heat load for TCA

Notation of abbreviations in the system of units

$$1/h = h^{-1}$$

$$W/m^2 = Wm^{-2}$$

$$W/m^2K = Wm^{-2}K^{-1} \gg$$

The standard heat loads are much too high and lead to oversized heating systems. >>

In regard to the calculation for heat load, there is the problem that a standard compliance calculation for heat load in accordance with ÖNORM EN 12831 and ÖNORM H7500-1 is not suitable for the low energy building standard. The title of the latter standard explicitly points out: The average thermal transmittance ("U-value") of the building envelope must not be under $0.5 Wm^{-2}K^{-1}$ for the application of this standard. The calculation for heat load in the standard for thermally superior building envelopes is subject to ÖNORM H7500-2. However, this is still in the standard project stage and is therefore not available to the planner.

The calculation for heat load according to standard ÖNORM H7500-1 results in oversizing for low energy and passive houses. The main reason for this is the time-independent (i.e. stationary) calculation approach based on very low outdoor temperatures (source: file NAT.xls on the OIB homepage www.oib.or.at). A calculation for heat load based on an outdoor air temperature of e.g. $-12,7^{\circ}C$ (location: Salzburg) implies that the building is permanently exposed to this temperature. Such outdoor climactic conditions occur at worst in the winter at the poles. Since we know that highly insulated buildings only react very slowly to extreme outdoor climactic conditions, the "safety" of standard-compliant calculations for heat load for low energy and passive houses proves to be much too high. The currently valid standards are not suited for calculation of the heat load of low energy buildings.

Taking into account inside heat sources

In addition, in standard-compliant calculation for heat load, the effect of all internal heat sources is ignored. This approach also proves unsuitable for low energy buildings since even the radiation occurring in an unused low energy building on a cloudy day can greatly reduce the heat load.

Passive House Planning Package (PHPP) as a tool for calculation for heat load

The problem outlined here of the absence of normative approaches for calculation for heat load of passive houses was discovered years ago at the Passive House Institute. This first led to a research project and then, as a consequence of the expansion of the Passive House Planning Package (PHPP), to a heat load calculation model. Since the new PHPP version 9.2 also enables calculation for heat load with climate data for a larger number of locations in Austria, using this program for calculating the heat load for low energy and passive houses is recommended.

If the result of the calculation for heat load is available for the rooms of the planned building, a quick decision can be made with rough estimation of whether the thermal activation of the ceiling can cover the heat load on its own.

Table 2 | Designations from the Greek alphabet common in building physics and in the standards.

Capital letters	Lower-case letters	Names	Parameter Property
	α	Alpha	Surface coefficient of heat transfer
Δ		Delta	Difference
	η	Eta	Heat supply efficiency
Θ		Theta	Temperature
Λ		Lambda	Thermal conductance by treated floor area (TFA)
	λ	Lamda	Thermal conductivity
	ρ	Tho	Mass density
Φ		Phi	Heat output or absorption
	χ	Chi	Effective thermal capacity by treated floor area

The **heat output by treated floor area** of a thermally-activated ceiling q can be described more simply by heating.

$$(1) \quad q = \alpha \cdot (\Theta_s - \Theta_i)$$

q is therefore proportional to the difference between the **average temperature of the ceiling soffit** Θ_s and **set temperature** Θ_i of the room. **Surface coefficient of heat transfer** α appears as the proportional factor in equation (1). For heated ceilings, α is to be set at $6.5 \text{ Wm}^{-2}\text{K}^{-1}$ according to ÖNORM EN 1264-5. For reasons of thermal comfort, the surface temperature of the heated ceiling section even under design conditions could not rise more than 4 K over the set temperature of the room. An upper limit for the heat output by treated floor area results directly in

$$(2) \quad q_{max} = 6.5 \cdot 4 = 26 \text{ Wm}^{-2}$$

The heat output by treated floor area of the thermally-activated ceiling considerably exceeding 25 Wm^{-2} should be avoided.

In the outlined rough estimation, the **minimum required effective heat exchanger surface** of $A_{R,min}$ is calculated by dividing the **calculated heat load of considered space** of Φ_{HL} (in Watt) by 25 Wm^{-2} :

$$(3) \quad A_{R,min} \approx \frac{\Phi_{HL}}{25}$$

The answer to the question of whether the thermal activation of the ceiling is suited for merely heating the room can now be answered by comparing the available net area of the ceiling and the mathematically estimated minimum

Estimation of applicability of TCA

q

Heat output by treated floor area (TFA)

Θ_s

Average surface temperature of the ceiling soffit

Θ_i

Set temperature of the room

α

Surface coefficient of heat transfer

q_{max}

Maximum heat output by treated floor area (TFA)

$A_{R,min}$

Minimum required effective heat exchanger surface

Φ_{HL}

Heat load of considered space

The quality of the building envelope must ensure a heat load of considered space of less than/equal to 25 Wm^{-2} of usable space. >>

value for effective heat exchanger surface $A_{R,\min}$. Whether the entire ceiling area of the pipe register can actually be used must be included in this consideration.

So, for example, requirements on room acoustics can mean that a part of the ceiling area is not available for heating. In this context, it must be emphasised that for smooth functioning of a thermally-activated ceiling, it is important to avoid of poorly heat-conducting layers in the ceiling soffit area. The ceiling soffit should only be thinly filled or plastered, whereby the selection of good heat-conducting plaster or filling material is preferred. Layers that absorb acoustics well are usually poor heat conductors. For this reason, no pipe register surfaces should be planned outside acoustic surfaces.

In the event that the entire ceiling surface can be covered with heating or cooling registers, it follows from equation (3) that the heat load of considered space relating to the effective space must be less than or equal to 25 Wm^{-2} . Such upper limits for the heat load of considered space are well-known for "conventional" passive houses. The requirement according to which a passive house should be heated solely via the supply of heated incoming air results in an upper limit of the heat load relating to the effective space of 10 Wm^{-2} and therefore in a planning goal which is difficult to achieve. Falling under the limit value of 25 Wm^{-2} for the effective area-related heat load when using thermally-activated storey ceilings, on the other hand, is an easily-implemented planning goal for low energy buildings.

TCA upvalues the living quality of low energy buildings. >>

According to equation (3), the required effective heat exchanger surface becomes smaller as the heat load is reduced. The heat load is, on the one hand, dependent on the thermal quality of the building envelope and, on the other hand, on the heat losses caused by incoming fresh air. Parameter studies have shown that heating via thermally-activated storey ceilings is possible without additional heating if the thermal quality of the building envelope corresponds at least to the low energy standard. If the ventilation heat losses by means of ventilation systems with heat recovery also fall, it has been shown that just a part of the available ceiling area is sufficient for heating such buildings.

Heat recovery must not lead to a deterioration of thermal insulation. >>

In connection with TCA, a low energy standard is spoken of if the calculation for heat load for the building falls below the net areal value of 25 Wm^{-2} . Test calculations have shown that this can also be implemented with building envelopes with a thermal transmittance of the outside wall of $U_{AW} = 0.15 \text{ Wm}^{-2}\text{K}^{-1}$ or less and passive house windows if no ventilation system is available.

In summary, it can be said that the question of the suitability of thermally-activated storey ceilings for heating rooms is closely tied to the thermal quality of the building envelope. Such a system will only function smoothly if the heat flows through the components of the building envelope can be kept low due to very good insulation and the ventilation heat losses are lowered by means of heat recovery systems. Heat recovery systems reduce ventilation heat losses very effectively if the building envelope is made air-tight. The issue of air tightness therefore becomes increasingly important.



Fig. 10 | Measurement equipment for the blower door test. © vōz

The position and design of the sealing level of a building is a part of planning and must be added to the design plans.

The air tightness of a building can be reliably tested with a so-called blower door test. Testing of the air tightness should at any rate be done as soon as is reasonably possible in order to allow for subsequent improvements. A value smaller than 1.0 h^{-1} must be ensured as the upper limit for the air change rate at a pressure difference of 50 Pa; for high-quality designs, a value smaller than 0.6 h^{-1} must be guaranteed.

The close relationship between the thermal quality of the building envelope and the design of the required effective heat exchanger surface shows that close cooperation and good communication between the architect or the master builder and the specialist planner are essential. Subsequent changes to the building envelope, such as the selection of windows of a different quality or a change to the U-values of the outer components must not be made without agreement from the building physicist and the in-house technician; otherwise the functioning of the entire system consisting of the building and heating or cooling can be impaired.

Smooth functioning of component activation is given if there are no large fluctuations of the heat recovery and losses occurring in the building interior. This prerequisite is generally met for residential use. Of course, unreasonable ventilation behaviour - e.g. continuous ventilation instead of brief and intensive ventilation in deep winter - can also create conditions which disrupt the energy

Quality assurance of the building envelope during production is essential

Run blower door test twice: Pre-test after completion of assembly work (installations in the sealing cover of the building) and acceptance test after completing of the building. <<

Notation of abbreviations in the system of units

$1/\text{h} = \text{h}^{-1}$

$\text{W}/\text{m}^2 = \text{Wm}^{-2}$

$\text{W}/\text{m}^2\text{K} = \text{Wm}^{-2}\text{K}^{-1}$ <<

balance in the building and lead to undesirable indoor climatic conditions. However, very poor user behaviour leads to loss of comfort and increased need for heating regardless of the heating system used.

TCA, forward-thinking technology

Shading equipment must be wind- and water-resistant and should function independently if possible. >>

Targeted avoidance of large fluctuations of inside heat in the residential area is an important topic, particularly in summer. The thermal activation of the ceiling can be used as a highly effective and energy-saving cooling system during hot spells. The prerequisite for reliable system function, however, is that the inside heat from solar radiation is dampened in its course and limited by means of targeted shading equipment. In this context, we would also like to again point out that the potential for cooling by means of TCA is of great significance because cooling residential buildings is becoming more important due to climate change. We must assume the currently accepted theory that residential buildings do not have to be cooled will no longer hold up in the near future. In this respect, TCA is to be classified as a forward-thinking planning measure.

Energy supply

Up until a few years ago, the investment, and in some exceptional cases, even the operating costs were decisive in the selection of an energy supply.

Integrated thinking and evaluation, in addition to the serious economic limiting conditions, are being adopted gradually in the decision-making process in the wake of the societal shift in values. Buzzwords such as the ecology of fuels, primary energy needs or emissions are gaining importance along with the growing appreciation for the environment.

Development of an energy concept

When developing energy-optimised buildings, the efficient use of renewable energy is playing an increasingly significant role. In addition to the frequent use of solar energy on-site with photovoltaics or solar thermal energy, there are countless alternative options, such as obtaining electrical current from solar or wind energy from the public grid. The environmental energy created elsewhere is not used directly on-site, but on the grid side. Which energy supply system is optimally suited for a construction project depends on a number of factors. The decision for or against an energy concept is therefore defined in large part by the requirements of the future residents. If, for example, the restriction of the summer temperature required by the users cannot be ensured by constructional measures alone, such as shading or night-time ventilation, the combination of heat pumps and component activation offers a possibility for cooling buildings. This can either be done by operating the heat pumps in cooling mode with an active compressor or, under certain conditions, this can be done passively by means of free cooling, e.g. without energy-intensive compressor operation. A well-thought-out concept for cooling can cover the required need for electricity with environmental energy and therefore not increase CO₂ emissions.

User requirements influence the development of the energy concept

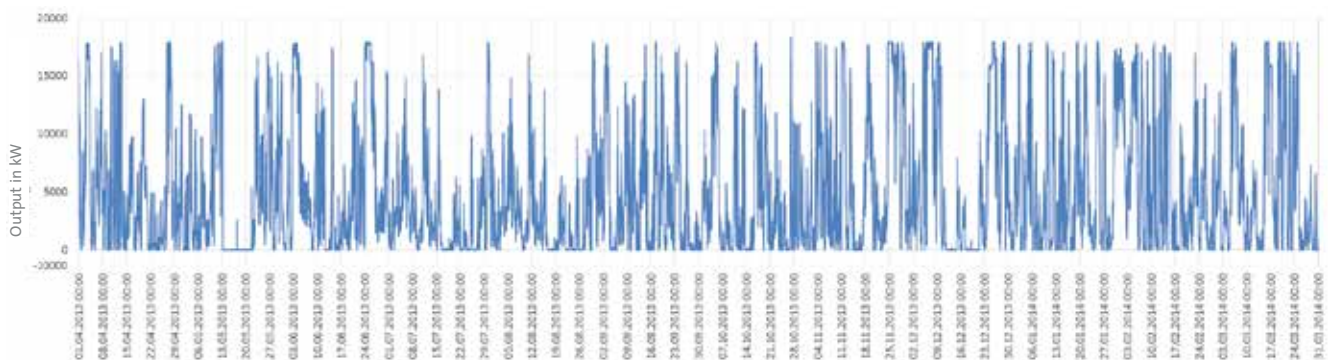

Fig. 11 | Energy harvest from wind energy. Output progression over the period of a year. (Source of data: [WEB15])



Fig. 12 | Application examples of photovoltaic modules for electricity generation.
Griffen © Energetica Industries GmbH; Dünnschicht Module © Prefa

Analysis of building location required

Based on an analysis of the building location and the prevailing climate there, the options for use of environmental energy can be narrowed down. At locations with low solar radiation, for example, the effectiveness of solar thermal energy and photovoltaic systems will be more limited, while using wind energy created on the grid side can be a wise alternative. If solar heat or electricity created by solar energy can be used to cover consumption for the entire year or there is the possibility of feeding this energy into a grid in a economically- and energetically-sensible manner, optimal results can be achieved with solar thermal energy and photovoltaic systems.

In any case, in photovoltaic systems the conversion of the electricity generated into heat should be done via heat pumps. However, it should be noted that in November and December, hardly enough yield from the sun can be expected on the part of the energy supply to cover the total heating needs.

Is district heating sensible for TCA?

Connecting to a local district heating system can provide to be wise both from an economic and ecological point of view. Since activated components only need a very low temperature to supply a building with enough heat and district heating systems grids are operated at relatively high temperatures, the temperature of the district heating must be mixed in at a suitable point in the system. Cooling buildings with this system is not possible without additional components.



Fig. 13 | Top and right
*Solar thermal energy system of
the Saalfelden climbing gym and
a Hörfarter office building.*
© Z + B/Wild & Team; © Wolfgang
Hörfarter/Hans Osterauer

Use of environmental energy generates a variety of operating conditions

The following figures 14 | 1 – 6 (© Simon Handler) show examples of various operating states which can occur when managing energy-storage concrete.

Fig. 14 | 1
Charging of the storage system with heat from environmental energy
 Heat generated from different energy sources can be stored within the building.

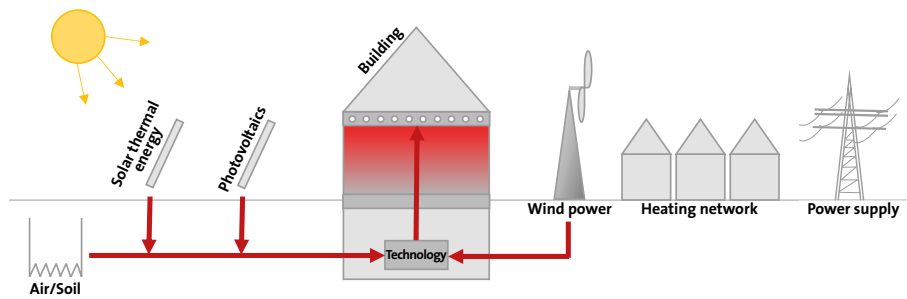

Fig. 14 | 2
Covering heat losses with stored energy (no environmental energy can be used)
 If no external heat source is available, the stored heat is used to cover heat losses of the building.

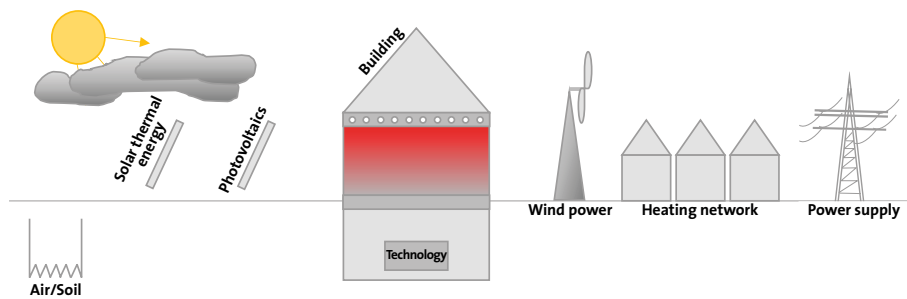
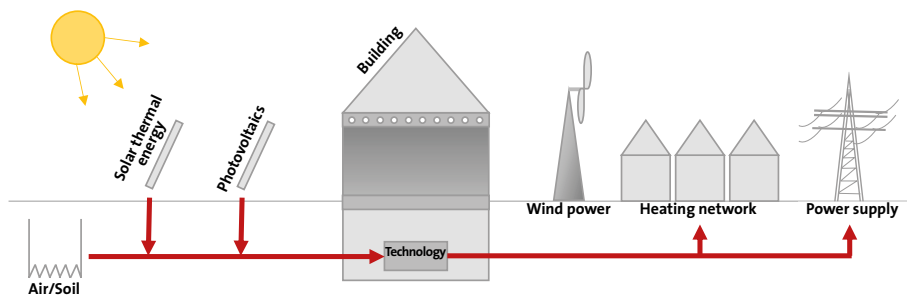

Fig. 14 | 3
Feed-in of energy generated on-site into public grids (Storage medium completed charged)
 If there are no heating needs or no option for additional heat storage in the building, the energy generated can be fed into (public) grids.



The thermal component activation system opens up new possibility for increasing the efficiency of systems in all cases while at the same time ensuring high comfort standards in the rooms. This is achieved by using the storage mass of the building.

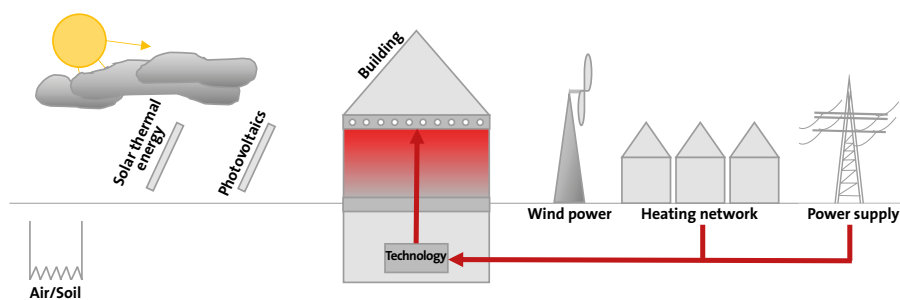

Fig. 14 | 4
Obtaining energy from public grids (no environmental energy can be used)
 If the "building" heat accumulator is exhausted and no environmental energy is available, the building is supplied from the existing grids until it is again possible to supply with heat or electrical energy from "environmental energy".

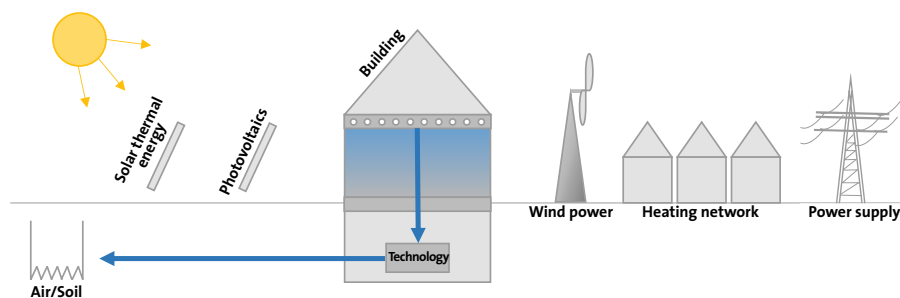

Fig. 14 | 5
Passive cooling (operation of a circulation pump)
 The energy needs for the drive of the circulation pumps is minimal for free cooling operation.

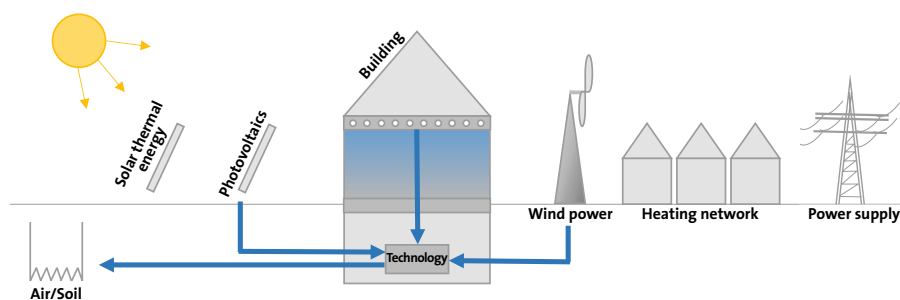

Fig. 14 | 6
Use of environmental energy for active cooling via a reversible heat pump
 The drive energy for the heat pump primarily comes from renewable energy sources (PV system, wind power).

The building as energy storage

Building structure as heat accumulator increases the potential for using environmental energy

The presence of environmental energy such as sun and wind often does not cover the energy needs of people and buildings at certain times. For this reason, only a relatively small share of the potential of environmental energy can be utilised. Only when storing this energy can a significant share of available sun and wind energy be used. The massive components of the load-bearing building structure provide a suitable and economical storage medium for heat from environmental energy and enable the realisation of high coverage rates.

Building heat accumulator smooths out peak loads of the energy supply

The storage mass of concrete components can be used in many ways. With solar thermal component activation or the combination of photovoltaics/heat pumps/component activation, the objective is to store as much usable solar energy on-site to be able to bridge long time periods without solar energy gain. When using wind energy from the public grid, it is possible to bridge shortages in the public power supply or to obtain electricity only at the times in which a large share of environmental energy (e.g. wind energy) is available in the grid. The mass of the building is used as a load-balancing storage system for the public electricity network.

Regulation of component and room temperatures as a key for success

Regardless of the type of energy provision, an obvious but often ignored point must be taken into account for the use of the storage mass when planning buildings with thermal component activation. In addition to the installed mass and the storage capacity of the materials used, the heat capacity of buildings depends heavily on the regulation of component or room temperatures. The connection between energy storage and the rise in temperature can be simply explained by means of thermal buffer storage. The temperature of the water rises when energy is stored in the buffer. The higher the storage temperature is above the output temperature, the more energy is temporarily stored in the buffer. The same can be observed when using building mass as heat accumulators. With thermal component activation, the temperature in the building is raised purposefully by storing energy. The temporarily-stored energy is then available later to cover the heat loss of the building. The storage mass of a building can only be used when temperature fluctuations can be permitted to a certain extent. Due to the requirements on the thermal comfort in rooms, however, these temperature fluctuations are comparatively minor and proceed slowly and steadily due to the high heat capacity of massive components. The temperature of the energetic management of the storage medium must be defined during planning with the building owners. The wider the temperature band, the more energy can be stored in the building. The value of 25 °C, maximum 26 °C, has proved itself in practice as the upper limit of the core temperature of the storage medium.

The basic principle for storing energy in the form of heat in the building structure is shown in the following figure.

**Easy regulation strategy
for thermal component
activation (TCA)**

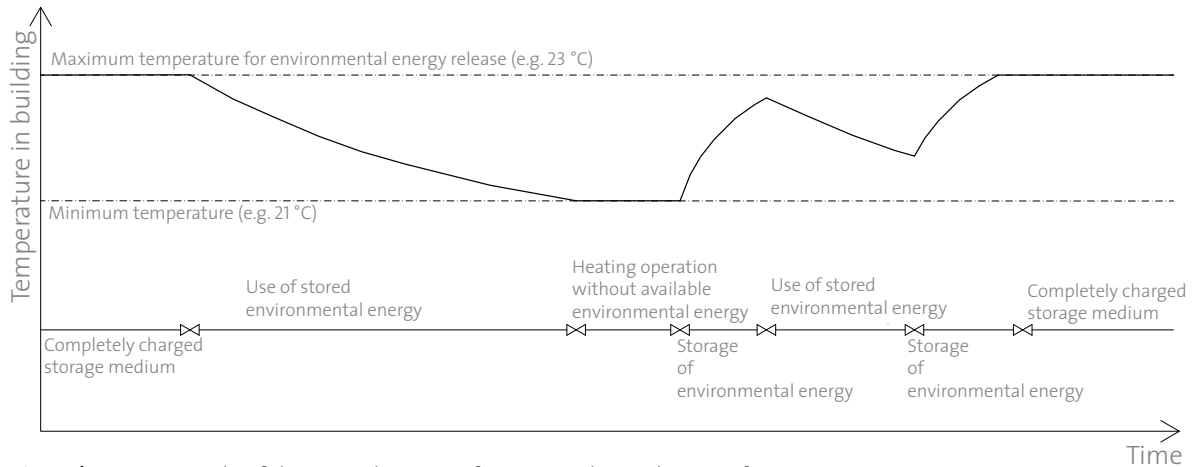

Fig. 15 | Basic principle of the control strategy for storing thermal energy from environmental energies inside the building structure. © Simon Handler

Controlling the temperature in the building and the charging condition of the components can be done in many ways. In practice, the room temperature and the temperature of the concrete core has proven to be the most important factor for monitoring the charging condition. The core temperature is measured by a sensor installed in the concrete and passed onto the building control system. The maximum permissible core temperature limits the charging of the storage medium. In addition to the core temperature, the temperature in the room is measured and transmitted to the building control system. The set value of the minimum temperature is set here.

Minor deviations in room temperature can be offered by zoning TCA by making settings in the distributors.

If the temperature in the building falls below the defined set temperature in an exceptional case, heat must be supplied to the building even if there is no available environmental energy (e.g. electricity from the public grid for operating the heat pump or for short-term use of a heat rod).

Recording the outside air temperature, as is done with outside temperature guided flow temperature control, is not necessary.

Component activation as heat output or heat extraction system

Efficient operation of heat pumps and solar collectors

In addition to the building physics aspects when using components as heat output or heat extraction systems, which is handled in chapters "Facts", "Prerequisites" and "Basis for planning", considerable benefits arise from the application of component activation for technical systems as well.

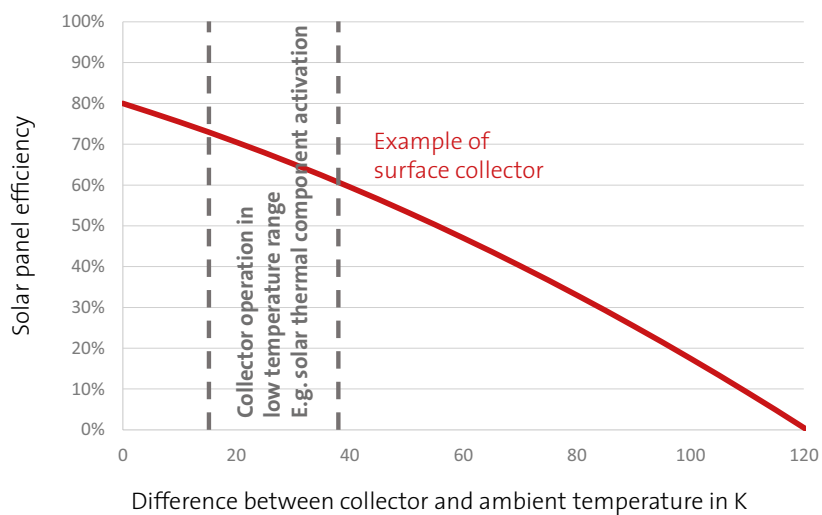
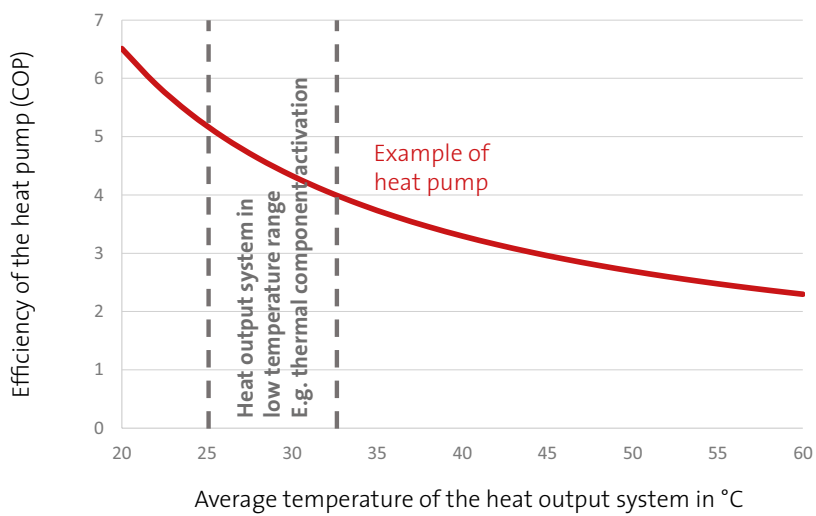

Fig. 16 | Dependency of efficiency of heat pumps and solar collectors as a function of system temperatures. © Simon Handler

Based on the use of the storage mass of the heat output system, operation of heat generators such as heat pumps can be designed in an extremely efficient manner. On the one hand, low return temperatures result for the heat pump, whereby the efficiency is very high, and on the other hand, frequent cycling (switching on/off) can be effectively prevented with non-modulating heat generators (i.e. without output adjustment to the current need or to the current energy supply). With heat pumps in particular, this leads to increased service life of the devices in addition to a reduction in start-up losses.

Since the system temperature is near the room temperature, the efficiency of both the heat pumps and the solar collectors greatly increases. The connection between the system temperature and the COP of an exemplary heat pump and the efficiency of a solar collector is shown in Figure 16.

In addition to improved system efficiency, there are also benefits when it comes to investment costs. Due to the large storage mass and the low system temperatures, smaller heat generators are often sufficient. Due to the large installation spaces compared to the implementation of floor heating, the required pipe lengths, and later also the construction costs, are reduced as well. If the line lengths are short, the pressure losses and therefore the need for pump power sink. While the arrangement of heating circuits is specified by the room borders when installing floor heating in the floor screed, it may be possible to do without exact room allocation when ceiling areas are activated. On one hand, this facilitates the laying of pipelines, and on the other hand, this results in pipe lengths of the same or very similar length, which facilitates the hydraulic balance of the system, thereby further reducing pressure losses.

**Economic benefits
of investment and
operating costs**

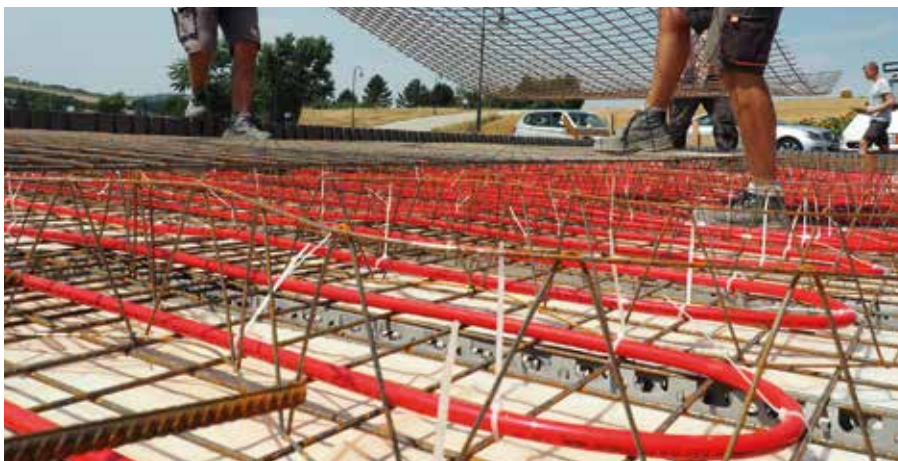

Fig. 17 | Heating circuits laid in the ceiling of a single-family house in Lower Austria.

© Thomas Schönbichler/CL

Active and passive cooling

Intelligent building concept optimises efficiency when cooling

Active cooling

Active cooling means cooling buildings by means of cooling machines or reversible heat pumps. The basic function of the heat pump is the same as when they are used for heating purposes. The temperature level in the cooling circuit is changed by means of an electrical compressor. In contrast to heating operation, heat can be taken from the components or building by reversing the circuit in the case of cooling and given off into the heat sink. In most cases, a reversible heat pump or cooling machine is operated as an air-water system. The heat from the building is given off into the outside air via the heat pumps in this system. In addition to air, soil or the groundwater can be used as a heat sink for active cooling.

Arguments **for** active cooling:

- > High heat output can be given out into the outside air over long periods of time if the system is designed appropriately.
- > When using the outside air as a heat sink, balancing heat input and heat removal is necessary.

Arguments **against** active cooling:

- > The often relatively high sound power level of the external units is a big disadvantage of air-water heat pumps. This can lead to noise complaints from the users and the neighbours.
- > Operation of the compressor run on electricity leads to increased energy consumption. It is therefore essential to limit the need for cooling as much as possible with constructional measures.

Passive cooling/Free cooling

With passive cooling, the low temperature or a suitable heat sink is used directly to cool the components. Operation of a compressor is not necessary. Since the outside air is typically not suitable for free-cooling operation in residential buildings and the cooling needs there because the temperatures are too high, alternative heat sinks with lower temperatures must be used. Soil, groundwater, river water, etc. can be used for this purpose. In this case, the permit situation for use of these heat sinks must be inspected.

Arguments **for** passive cooling:

- > Since no reversible heat pumps or cooling machines are operated and only circulation pumps are required, the electricity needs for passive cooling are extremely low.
- > When using groundwater, high outputs can be discharged even over long periods of time if the water flow is sufficient.
- > Flat collectors (ground collectors) are a very easy and economic solution.

Arguments **against** passive cooling:

- > With passive cooling through soil, it must be noted that the soil heats up due to the heat removed from the building. If cooling operation lasts for long periods of time, the temperature of the soil can rise above that which can be used for free cooling. Caution: The performance of passive cooling through the soil falls during longer periods of sole cooling.
- > In order to ensure the performance of the soil as a heat sink over many years, heat input and heat extraction must be balanced out. It is therefore useful to use the heat sink as a source of heat in the winter for heating the building via a heat pump.
- > The investment costs for the exploitation of heat sinks are generally higher than for discharging heat into the outside air.

System variants

Variation options for optimising TCA

The possibilities of integrating energy-storage concrete into a building concept in a sensible way are very extensive. Thanks to its extraordinary properties, component activation opens new opportunities to combine different systems. In order to use the storage mass of the building to improve energy efficiency, it is necessary to optimise the interplay between heat generation via the control system and the building itself. The consideration of the connections between structural engineering and building technology presents a great challenge for planning and execution.

The basic principles to be considered when choosing different system components to achieve optimum coordination of the overall system are explained in Figures 14|1 – 14|6.

Three different systems show the range of variants of TCA

Three different system variants are singled out below. The function and the resulting properties of the system are described and the planning principles are explained.

- Variant 1 | Energy supply via solar thermal energy
- Variant 2 | Energy supply via photovoltaics and heat pump
- Variant 3 | Energy supply via wind energy and heat pump

Active and passive charging and discharging processes

Energy storage mediums based on water (e.g. buffer storage) are used to actively store heat. The storage medium is actively discharged by outside intervention. If there is need for heat in a room, heat is removed from the storage medium with pumps.

Charging is also active in the case of thermal component activation (with pumps), as is the case with the overwhelming number of other storage mediums. If, for example, environmental energy is available, heat is actively introduced (by means of conducting through a heat carrier) into the concrete components and stored there. The stored heat is available in the building on the following days. The discharging process of the storage medium is passive with TCA, compared to storage media based on water. If concrete components are used for cooling rooms, these processes are reversed. Discharging the heated-up components is done actively, i.e. the heat is conducted through a heat carrier by means of pumps. "Cooled" components, however, are charged passively by heat extraction from the room.

Variant 1 | Energy supply via solar thermal energy



Fig. 18 | Example for system variant 1 – Energy supply via solar thermal energy
Hallwang community centre © Adrian Kuster, Millstatt

In addition to the collector area, the system hydraulics and control system as well as the heat output systems, the energy savings achievable by the use of solar thermal energy depends heavily on the type of available heat accumulator. With TCA, the massive components of the load-bearing building structure are a suitable and cost-effective storage medium for heat.

The functional principle for solar thermal component activation is easy to explain. With solar radiation supply, the heat given off by the collectors is stored in the activated components by the installed tube register, whereby the temperature not only rises in these components but also in the entire building structure. If the room temperature falls below the temperature of the enclosing surfaces, the heat stored in the components is given off into the room.

The upper and lower limit of the temperature of the heat accumulator are mostly determined by the sense of comfort of the users. When it comes to charging activated components, a maximum core temperature of 25 °C emerges. The adjusting room temperature is about 1 °C to 1.5 °C lower. For example, the lower limit of the room temperature can be selected as 20 °C. The room temperature moves in the range of 4 K, which corresponds with the ideal human level of comfort. Due to the risk of condensation on the surface, the temperature of the heat accumulator must not sink below 19 °C in any event in the case of cooling. The amount of energy stored in a building is determined by the "usable" building masses, which are primarily massive components not separated by insulation, and the permitted temperature difference in the heat accumulator.

The lower the heat losses of the building are, the longer the bridgeable time period to the next charging process of the storage medium is. In buildings with high-quality building envelopes and effective heat recovery, it is typically possible to bridge time periods of a week without affecting the level of comfort.

High efficiency of solar collectors due to low system temperatures

As already specified in chapter "Facts", low system temperatures play a significant role in the efficiency of solar thermal energy systems. The lower the temperature of the heat carrier medium in the solar circuit, the higher the efficiency of the solar collector. For this reason, a high-flow system with very high volume flow in the collector circuit is chosen for heat supply by solar thermal energy. The heat is given out to the components without temporary storage whenever possible. The high-flow concept ensures that the flow temperatures of component activation do not rise too steeply and that charging components is possible even if solar yields are high. The temperature of the heat carrier can be raised to 45 °C for a short time, but the concrete storage medium must not be charged above the previously mentioned core temperature. The charging process of the concrete storage medium is ended by the system control using sensors installed in the concrete. When designing the system, it must be ensured that the high volume flows do not destroy the temperature stratification in the buffer storage.

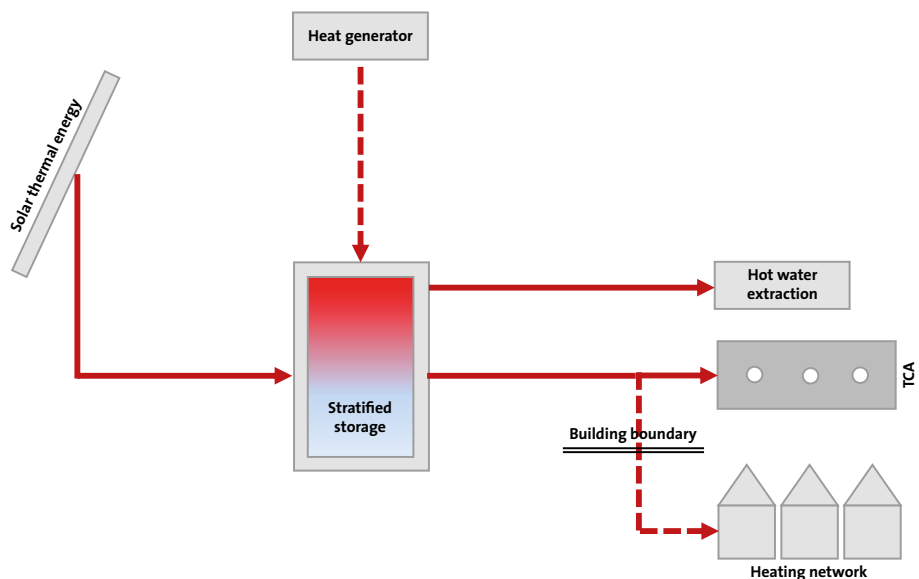

Fig. 19 | Schematic sketch for system variant 1 – Energy supply via solar thermal energy.

© Simon Handler

This system concept is designed to cover as much of the heat needs for the room heater as possible. In the winter months, solar thermal energy is therefore used only for domestic hot water supply if the components are already fully charged. In order to achieve the highest possible solar yields during the heating period, the collectors used are positioned at relatively steep angles. Since the sun is low during the winter months, high yields can be generated with setting angles of 70° and 90° at these times. This also ensures that snow will slide off during the winter months. The steep positioning of the collectors also has the effect of lowering heat input in the summer months. Since solar thermal heat is typically only used for the hot water supply at this time of year, need is comparatively low and can be covered despite the steep angles.

As large collector surfaces are used in this variant, more heat is usually produced than is needed for the provision of hot water in summer and in the transition periods. That is why integration into local heating grids is wise in this case. Excessive heat can be given off to surrounding heat consumers in this case, bringing in a profit.

Figure 19 shows a schematic sketch with the essential system components of heat provision for the combination of solar thermal energy and component activation. The use of flat plate collectors has been proven expedient from an economic and technical point of view. The dimensions of the heat exchanger between the primary circuit of the solar power system, which is filled with glycol, and the rest of the system are significant when designing the solar circuit. In general, selecting an external heat exchanger is recommended. In order to keep the temperature in the primary circuit low and thereby the efficiency of the collectors high, the heat transfer surface must be generous.

Although a solar coverage rate of up to 100% can be achieved under certain conditions, it is typically necessary to provide an additional heat generator. This also applies for residential buildings, in which heat is also needed for hot water as well as heating the rooms. Different generators can be used depending on the heating needs. Heat pumps or biomass boilers can achieve the best results from an energy point of view. In the simplest case, an electric heater rod placed in the buffer can be enough. Obtaining heat from a local heating grid (a neighbour, etc.) is also a sensible alternative. The dimensioning of the system during project planning is based on economic as well as ecological aspects. Consultations must be held with the building owner to determine whether the highest efficiency technically possible should be achieved, or whether the most economic overall system should be the goal.

Room heating has priority

**Heat surpluses in summer
can be used sensibly
in other ways**

**Heat exchanger with large
heat transfer surface**

**Select overall system which
makes sense economically
and energetically**

Additional components are necessary for cooling the building in variant 1! >>

High solar efficiency can be achieved for comparatively low investment costs with the solar thermal energy and component activation system variant. However, cooling buildings by component activation is not possible without additional system components. For this reason, it is very important to prevent overheating in summertime with construction measures for this building concept. If constructional measures are not enough, fountains, soil sensors or floor collectors are easy energy sinks for TCA.

A site location must be done without fail

Whether the concept of TCA energy supply using solar thermal energy is possible for a concrete project must be determined in the design phase by means of a analysis of meteorological and topographical limiting conditions as well as the planned use of the building. In particular, it must be ensured that the steeply positioned collectors are not shaded by surrounding buildings or natural obstacles. That is why the combination of solar thermal energy and component activation is rarely possible in urban areas. While it must be ensured that the rows of collectors do not shade each other when installed on flat roofs, attention must be paid to the orientation of the entire building when collectors are integrated into the façade or installed on steep roofs. The selected concept therefore influences even the first architectural draft and must therefore be defined early in the planning phase.

Pros & Cons - Variant 1 | Energy supply via solar thermal energy

- + Use of solar energy on-site
- + High coverage rate despite low buffer storage volume
- + High coverage rate with comparatively low investment costs
- + Simple and sturdy technology
- + Largest possible independence from energy providers possible
- + Lowest CO₂ emissions possible
- Meteorology and topology of the environment influence coverage rate
- Energy gain in summer often cannot be used fully
- + Active or passive cooling not possible without additional systems

Variant 2 | Energy supply via photovoltaics and heat pump



Fig. 20 | Example for system variant 2 – PV-heat pump-component activation, Elsbethen Austraße multiple-family house, Salzburg. © Michael Harrer

Another possibility of using sun energy to control the temperature of buildings is combining photovoltaic systems, heat pumps and TCA. The use of heat pumps is one of the most frequently used variants in single-family houses. The combination of heat pumps with photovoltaic systems is already widespread. Intelligent control strategies are used to try to cover the largest-possible share of the electricity consumption of the heat pump with PV electricity produced on-site. This concept can be optimised by using energy-storage concrete.

It must be noted that solar collectors provide relatively low yields at the time of the highest need for heat. Covering the entire need for electricity of the heat pump drive to cover heating demands is therefore typically not possible in the winter months.

In contrast, high radiant heat gains are present during periods of nice summer weather which can be used both for domestic hot water supply and for cooling the building through the use of (reversible) heat pumps.

Modulating heat pumps for optimising energy efficiency

With these system variants, the attempt is also made to cover the largest-possible share of the heating needs of a building with solar energy. Compared to the system variant with solar thermal energy supply, the solar energy which hits the PV panels is not converted into heat but into electrical current. Later, the current generated in this way is converted into heat using a heat pump, thereby supplying the building. In order to cover the largest-possible share of the entire heating needs with PV current, the heat pump is only put into operation if there is sufficient solar power, whenever this is feasible. Energy-storage concrete is used in order to bridge long periods of time without PV current production. As with TCA supply with solar thermal heat, the storage space is raised to a higher temperature level. As soon as the desired core temperature is reached, the electricity generated is no longer used for heat generation via the heat pump, but is used by other consumers or fed into the public grid. As with the previous variant, the core temperature is defined during the planning phase.

In order to optimally adjust the power consumption of the heat pump to PV electricity production, it makes sense to use modulating (i.e. power-variable) heat pumps. This measure can significantly increase self-consumption.

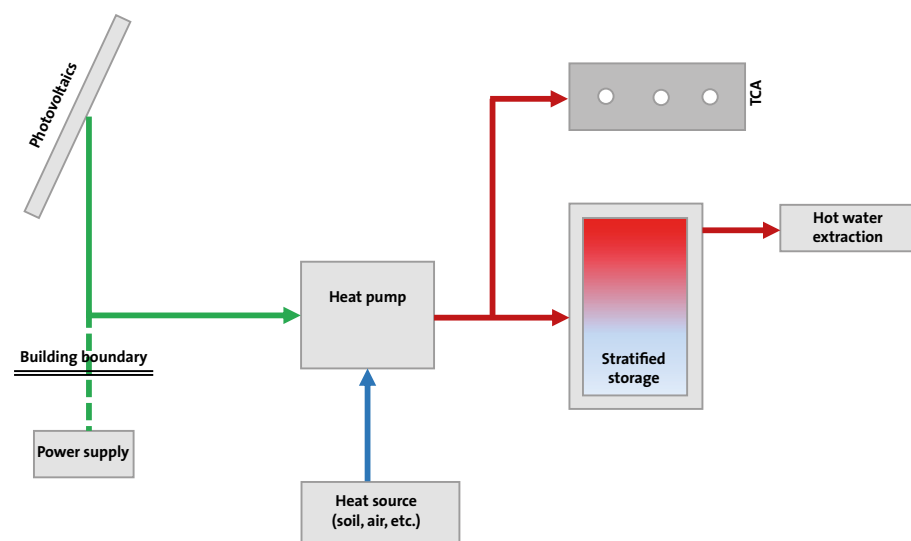

Fig. 21 | Schematic sketch for system variant 2 – PV-heat pump-component activation.

© Simon Handler

Figure 21 shows a schematic sketch with the essential components of heat provision for the PV-heat pump-thermal activation system variant. In addition to the PV system and the heat pump with corresponding heat source, a storage medium is needed for the hot water supply. It must be noted here that high storage temperatures result in reduced heat pump efficiency. This conflicts with the specifications of ÖNORM B 5019, which regulate the hygiene-related planning and implementation of centralised drinking water heating systems.

ÖNORM B 5019 regulates hygiene-related planning, implementation, operation, maintenance, monitoring and renovation of centralised drinking water heating systems. In principle, it specifies that heated drinking water must be 60 °C when entering the distribution system. However, the scope of ÖNORM B 5019 rules out single- and double-family houses as well as systems for decentralised drinking water heating.

Basically, heating up drinking water via a fresh water station is suggested. The efficiency of a heat pump falls quickly as the flow temperature increases. In addition, temperatures of maximum 60-65 °C can be reached with most heat pumps. This means it is not possible to store heat by greatly increasing water temperature. The storage volume of the domestic hot water supply is therefore an important criterion for the efficiency of the entire system. A respectively large volume should therefore be selected to be able to bridge longer periods of time without PV electricity.

In contrast to solar thermal energy collectors, the PV panels are not installed as steeply. Since the excess PV electricity is used by other consumers and can possibly also be sold, a steep setting angle for optimising energy production is not expedient. As a rule, the highest yearly yields of south-facing PV modules are reached at about 30° above the horizontal plane. In order to ensure satisfactory performance in the heating season, a setting angle of about 60° is recommended. This setting angle also ensures that snow will slide off during the winter months.

**Hygienic drinking
water heating**

**Designing hot water
storage system for use
over several days**

**Setting angle of the
PV collectors**

Heating and cooling possible with the same system

One of the big advantages of the combination of photovoltaics-heat pump-TCA is that cooling can be either active or passive, depending on the heat sink. The power consumption of the heat pump and the size of the PV system are coordinated to optimise the heat supply of the building. Cooling is mostly needed in periods with high irradiation intensity. The energy needs of the heat pump can usually be covered.

However, both active and passive cooling requires energy consumption. For this reason, cooling via component activation must be understood as a supplement to constructional measures and should be reduced to a minimum.

Pros & Cons - Variant 2 | Energy supply via photovoltaics and heat pump:

- + Use of solar energy on-site
- + Low energy costs
- + Solar energy yields can also be completely utilised outside of periods of heat
- + Active or passive cooling possible with low additional investment
- + Only one energy source for supplying the entire building
- Solar yield at the time of greatest need for heat is relatively limited
- Meteorology and topology of the environment influence system performance

Variante 3 | Energy supply via wind energy and heat pump



Fig. 22 | Example for system variant 3 – wind-heat pump-component activation, single-family house in Lower Austria © Aichinger Hoch- u. Tiefbau GmbH

The system variants already presented are based on utilisation of environmental energy directly on-site. However, there is the option of using environmental energy such as wind or solar energy created away from the building site for TCA and also for the domestic hot water supply.

The output of wind power systems in Austria have been continuously expanded for years. While electricity production with, for example, fossil fuels can be adjusted relatively well to the current need, solar or wind energy can only be generated at the times at which the respective energy source can be utilised. Due to the fluctuating supply of energy, generation peaks and shortages arise. The fluctuation between electricity needs and electricity generation is also reflected in the electricity prices. At times of high electricity production from renewable energy, electricity price sinks on the stock exchange. A result of this fact is that individual windmills are separated from the grid and electricity production from renewable energy is reduced. This measure is taken primarily to prevent peak loads.

The storage mass of buildings can be used to balance out peak loads. The wind power generated at times of peak loads is converted into heat by means of a heat pump at times of peak loads and saved in the building or used to cover heat

**Constantly growing
production of wind energy**

**Energy-storage building
for smoothing out
peak loads**

losses. The building functions as an effective and economic energy storage system for the public electricity network. The type of use of energy surpluses could be a considerable advantage for energy supply companies in the future.

Smart grid application for optimised environmental energy use

The functioning of the TCA energy supply system variant by means of wind energy and heat pump can be described as follows: The energy supplier generates a wind release signal at times of high generation capacities in the wind parks and passes this on to the building control system of the energy consumer with a remote signal. During release periods, heat can be stored in the concrete storage medium, if applicable. This makes it possible to save heat generated from wind power intelligently and economically in the load-bearing structure of a building. The stored energy is given off into the rooms in accordance with the already-described laws of TCA. The goal is not to fall below the lower room temperature limit in a phase without wind release. If the room temperature falls below the limit value in individual cases, the heat pump is supplied with power from conventional production and keeps the building above the desired temperature with normal operation. However, it has been shown that wind power is more available in the heating period and it is rarely necessary to recharge with conventional production methods.

Selection of heat pump power adapted to the system

While it is typically wise to adjust the performance of heat pumps to the calculated heating needs as far as is possible, it is essential to provide higher heat pump output for this system variant. In times of wind release, the system must be able to store large outputs in the concrete storage medium in a short period of time.

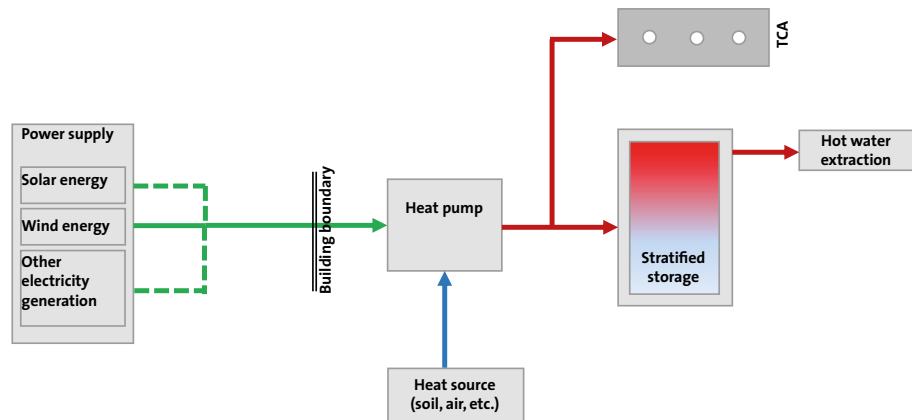

Fig. 23 | Schematic sketch for system variant 3 – Energy supply via wind energy and heat pump. © Simon Handler

Fig. 23 contains a schematic sketch for the system variant with TCA energy supply via wind energy and heat pump. The system components used do not differ from those of any heat pump system. In order to enable communication between the energy supplier and the technical system in the building, only a release signal is needed, which is processed by a controller.

As with PV-heat pump-component activation system variant 2, sufficient dimensioning of the storage system for domestic hot water supply and hygienically-impeccable treatment of hot water must be ensured for the combination of wind energy, heat pump and component activation.

Hot water supply

Pros & Cons - Variant 3 | Energy supply via wind energy and heat pump:

- + Simple and sturdy technology
- + Low investment costs
- + Low energy costs
- + Only one energy source for supplying the entire building
- + Active or passive cooling possible with low additional investment
- + No influence on the architecture by solar collectors, etc.
- + Meteorology and topology of the environment do not influence efficiency
- Dependence on energy supplier
- Energy costs depend on the respective electricity rates



Fig. 24 | The power house with heat pump, hot water boiler, circulation pump and distribution lines, etc. is assembled manageably in the smallest possible space.

© FIN – Future Is Now, Kuster Energielösungen GmbH

System control

TCA takes over the role of a "radiator" in the building. The overall system for thermal conditioning of a building functions well when the performances of the heat supplier and the "radiator" are well coordinated with one another. The system control performs this task.

TCA plays the role of the "radiator" for the building and its technical components. It is responsible for heat output to the rooms in winter. In summer, it ensure a cooling effect by discharging excess heat.

Task of the system control

The radiator must be differentiated from the heat supplier. Different options for supplying heat in the winter or discharging heat in the summer have already been presented and discussed in chapter "Energy supply". The overall system for conditioning the rooms of a building functions well when the function of the heat supplier and the "radiator" are well coordinated with one another. The system control performs this task.

The heat transport from the energy supplier to the radiator is generally done with a liquid by way of convection with TCA. This is called a heating medium or cooling medium in the following, although it is of course the same fluid circulating in a closed system. With convective heat transport, heat quantities are transported through the movement of the heating medium or cooling medium. This coupled mass and heat transport is achieved with TCA using a circulation pump. The activation of this pump is an important component of the system control to be discussed here.

Heat transport

In winter, the heating medium is pressed from the heat supplier into the pipe register installed in the concrete of the storey ceiling by the circulation pump. The heating medium gives off heat there depending on its temperature, the temperature of the ceiling and the flow velocity in the pipe. It then flows - cooled-back into the heat supplier and is then warmed up again. The type of heating depends on the type of heat supplier. Heating is passive with domestic hot water collectors - provided there is sufficient sun radiation. The electricity needed from the circulation pump is the only demand for energy. With active heating on the other hand, the demand for electricity of the heat pump or heater rod is also a factor.

Heat transport in winter

Heat transport in summer

In summer, cooling is also done with convective heat transport. The approach often used in which heat is transported in the summer is not only senseless, but can also quickly lead to misjudgements. "Heat" is a form of energy and is given off in kWh or kJ. On the other hand, "cold" describes a condition and is measured in °C.

The circulation pump also ensures the flow of cooling medium through the pipe register in cooling operation. Surplus heat stored in the ceiling is transported away through the cooling medium. The transported amount of heat also depends on the temperature of the cooling medium, the temperature of the ceiling and the flow velocity of the cooling medium. The cooling medium heated up by flowing through the pipe register flows back into the cooling system, is cooled down there and then pressed back into the pipe register. The liquid can be cooled actively or passively, as is the case in winter. With passive cooling, the cooling medium is guided through areas of low temperatures in the pipes and gives off heat there. Common examples of such areas are soil, groundwater or river water. The demand for energy with passive cooling is limited to the electricity of the circulation pump. Of course, cooling can also be done actively with a cooling machine or a heat pump with additional energy input.

Requirements on the total system

The overall system consisting of the building, heat supplier and TCA must fulfil the following requirements to the best possible extent:

- > Ensuring high thermal comfort in rooms throughout the entire year and also during extreme outside climatic conditions.
- > Energy-efficient operation of the system for conditioning (i.e. heating and cooling) rooms.
- > Predominate use of renewable energy for conditioning the building.

These requirements result in a number of important aspects regarding the system control.

In order to ensure high thermal comfort in the rooms, it must be guaranteed that temperatures in the rooms must not deviate from a certain band (also) defined by the users of the rooms. Of course, this requirement can only be upheld if the temperature development in the rooms is permanently controlled by means of room thermostats. The room thermostat is part of the system control and sends out signals which are used later to control the heat supplier and the circulation pump.

In winter, the reports from the thermostat prevent the room temperatures measured by the thermostat from falling below the set temperature. If the room temperature approaches the lower limit of the temperature band, the circulation pump is put into operation due to the thermostat reports and heat is supplied to the activated ceiling.

High thermal comfort

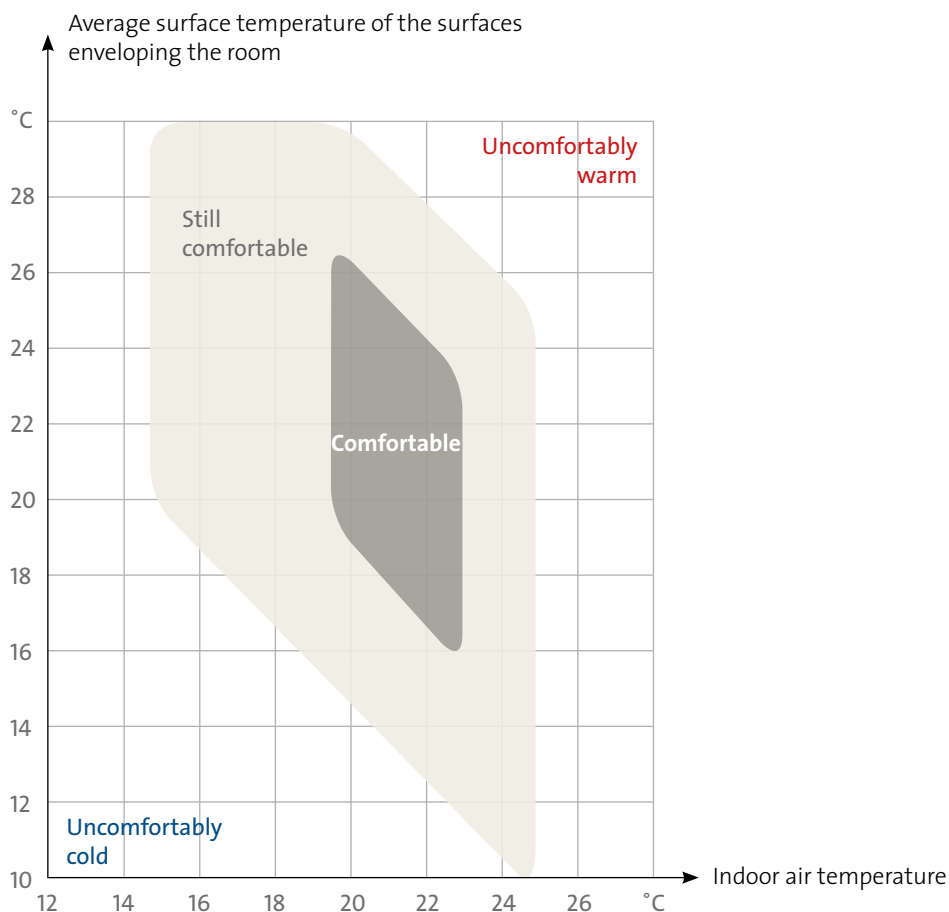

The goal is a Δ (Delta) of maximum 4 K between surface and room temperatures in the centre of the comfortable area. <<

Fig. 25 | Comfort range of surface temperature to air temperature.
Source: www.thermische-behaglichkeit.de/thermische-behaglichkeit.
The comfort criteria are easy to uphold with TCA. © Z+B

In summer operation, the signal of the room thermostat, on the other hand, serves to prevent the room from overheating. If the room temperature approaches the upper limit of the temperature band, the circulation pump is put into operation and heat is removed from the activated ceiling by means of through-flow through the pipe register.

Another important point for ensuring high thermal comfort in the room is prevention of extreme temperature differences between the individual room-adjacent surfaces on the one hand and between the surface temperatures and the room air temperature on the other hand. In order to reliably prevent the temperature from exceeding the maximum permitted surface temperature of the ceiling in winter and from falling below the minimum permitted surface temperature in summer, the temperature development is measured by a second sensor in the area of the heat register - in the following, this will be referred to as the "core temperature". Empty pipework is installed in the concrete at the height of the pipe register, into which the temperature sensor is later inserted.

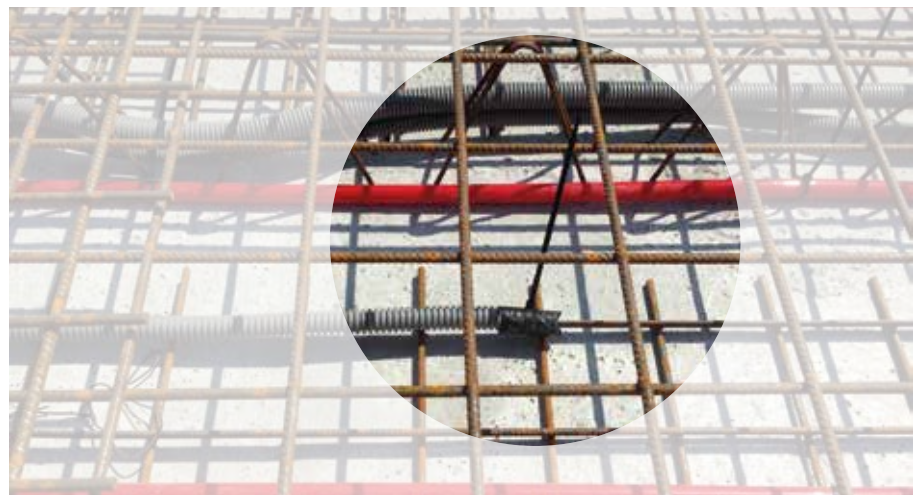

Fig. 26 | Installation of a temperature sensor in the area of the heat register to measure the core temperature. © Aichinger Hoch- u. Tiefbau GmbH

If the core temperature exceeds an upper limit in winter defined when adjusting the system, the heat supply is interrupted by switching off the circulation pump. Values in the range of 25 °C to 26 °C have proven successful in practice. Due to the very high heat capacity of the concrete ceiling, its temperature falls very slowly after the circulation pump is switched off. Since the surface temperature of the ceiling soffit also only falls slowly, the heat output of the ceiling remains nearly unchanged over long periods of time. Not until the temperature measured by the room thermostat approaches the set temperature is heat again supplied by switching on the circulation pump, restarting the charging cycle of the ceiling.

The system control works in the same way for cooling. In this case, the room thermostat sends the switch-on signal to the circulation pump if the room temperature approaches the set upper limit. For residential use, this upper limit is specified as 27 °C by ÖNORM B8110-3. In practice, this limit is usually set at 26 °C. Of course, the users are involved in setting the maximum temperature.

Due to the through-flow of the cooling medium through the pipe register, heat is extracted from the ceiling, cooling it. Cooling must be restricted for reasons of comfort and to prevent condensation. The core temperature sensor handles the restriction. If the temperature registered by this sensor falls below a set minimum value – this is typically in the range of 20 °C –, the circulation pump is switched off, thereby ending heat extraction. Due to the very high heat capacity, the temperature of the ceiling rises slowly. As soon as the room temperature sensor reports that this upper temperature level is being approached, the cooling circuit through the circulation pump is put back into motion.

One of the prerequisites for energy-efficient heat supply is automatically fulfilled with the necessity of very low temperatures of the heating medium with TCA. They are normally under 30 °C. Only at full capacity - i.e. under extremely cold outside climatic conditions - are temperatures of the heating medium around or just above 30 °C. If domestic hot water collectors are used as heat suppliers, the temperatures of the heating medium can get up to about 45 °C if sun radiation is high, even if through-flow is high. If this does not occur over a long period of time, the ceiling is not too strongly heated due to its high heat capacity. Otherwise, the core temperature sensor signal ensures the circulation pump is switched off.

With cooling as well, the basic requirement for energy-efficient cooling operation is fulfilled due to the comparatively high temperatures of the cooling medium – they are in the range of 20 °C and above. Solutions for passive cooling are often also found here.

Of course, in this context it must be clearly indicated that preventing high demand for cooling is one of the most effective foundations for energy-efficient cooling operation. For residential use, the prerequisites for this are defined in the planning phase. The sensible choice of window sizes depending on their orientation and the provision of easily-to-operate, sturdy and effective shading equipment helps to limit solar heat recovery. In addition, intensified night-time ventilation combined with massive construction can be used effectively to increase temperatures in the building during high summer hot spells.

Energy-efficient operation



Fig. 27 | Pipe diameter, pipe length and thereby flow resistance are criteria for dimensioning the circulation pump. © FIN – Future Is Now, Kuster Energielösungen GmbH

The electricity consumption of the circulation pump must be kept low for energy-efficient operation. In addition to the selection of an energy-saving pump type, the length of the heating circuit and the pipe diameter play a key role in this context. In order to keep the flow resistance within manageable limits, the pipe length of a heating circuit is in the magnitude of 100 to maximum 150 m. Although the pipe diameter between the pipe register and the ceiling does not play a major role when it comes to heat transfer, very small pipe diameters should be avoided if the pipe lengths are long because of the sharply rising flow resistance. Values of 13 mm and above have proven successful as pipe nominal widths.

If possible, heating circuits are planned with pipe lengths of around 100 to 150 m. >>

The necessity of supplying the building via several heating circuits makes it advisable to connect the definition of the heating circuits with the zoning of the building. A temperature zone is an area with the same set temperature and nearly the same usage. The provision of different set temperatures does not only help comply with user requirements, but also supports energy-efficient operation. In highly-insulated buildings, the tendency to balance out the temperatures between different temperature zones is reinforced. However, practice has shown that temperatures differences in the magnitude of 2 to 3 K can be produced and maintained with the TCA control system.

Temperature differences of 2 K to 3 K inside highly-insulated buildings can be planned and controlled. >>

Renewable energy

In addition to the requirement of lower temperatures of the heating and cooling medium, a characteristic for the efficient use of renewable energy is utilisation of an irregularly-occurring energy supply. As already stated, due to the large heating areas, low temperatures of the heating and cooling medium are not only possible, but actually necessary for the TCA as a "radiator".

The high heat capacity of concrete ceilings also ensures that large amounts of heat can be both absorbed and given off without drastically changing the temperature distribution in the ceiling. This means irregularly-occurring amounts of heat from the ceiling can be absorbed, temporarily stored and then given off with a delay.

When it comes to heating, this means that the heating medium heated up by means of domestic hot water collectors can be directly fed into the activated ceilings. On the other hand, hot water provided by a heat pump driven by means of renewable energy only at irregular intervals can be used as a heating medium.

When it comes to cooling, the high heat capacity of the storey ceiling ensures that the heat from the rooms is absorbed by the ceiling over long periods of time without increasing its temperature too much. The stored heat can be discharged by means of the through-flow of the pipe register if renewable energy is available for operation of the circulation pump and cooling system. The prerequisites for the use of renewable energy in systems with TCA are therefore fulfilled to a high degree throughout the whole year.

In summary, the system control for buildings conditioned by TCA is very simple. The two temperature sensors control the operation of the heat supplier or the cooling system and the circulation pump. The system is adjusted once after the building is erected. After a few months of operational experience, fine adjustments can be made based on any user wishes. The system then runs automatically. User intervention is typically not necessary and is limited to small changes to the set temperature at the most.

The overall system consisting of the building, heat supplier and TCA unites the three types of heat transport in a sensible way:

- > The heat transport of heat suppliers to TCA is purely convective. The heating or cooling medium is pressed into the pipe register through the circulation pump. This not only transports the liquid, but also the heat contained inside.
- > The heat is transported from the pipe register into the ceiling by means of heat conduction. Heat conduction is an automatically-occurring balance process in which heat flows from areas of higher temperature to areas of lower temperature. If the liquid is warmer than the ceiling, heat flows into the ceiling (in the case of heating). If the ceiling is warmer than the liquid, the heat is given off into the cooling medium (in the case of cooling).
- > Heat is transported from the ceiling soffit to all other room-adjacent components by means of heat radiation. Heat is radiated from all bodies depending on their temperature and surface properties. Radiant heat transfer in the

**Buildings, heat suppliers
and TCA as overall system**

TCA balances out the temperature between all surfaces and the room air independently and at all times. >>

- Operative temperature
- Heater output
- Outside temperature

The operative temperature is a measure for the temperature felt in the room. >>

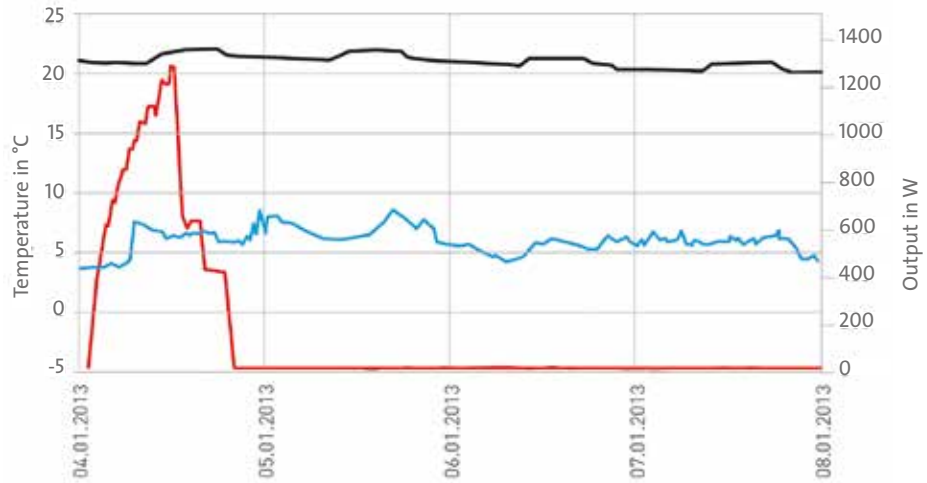

Fig. 28 | Simulation room at Innovations- und Forschungsstelle Bau, Salzburg, Austria: Temperature and output drawings in the research period. After switching off the heating, the operative temperature falls only minimally. © ARGE Nachhaltige BAUTEILAktivierung

Summer mode during hot spells

Progressive warming of the climate encourages taking a closer look at the system control of TCA for cooling buildings.

The heat receptiveness of a component depends on the difference of the temperature at the beginning and end of a charging process in addition to the material properties. In order to use the storage capacity of a building optimally, it makes sense to cool the building down to a sensible level before hot spells occur. During hot spells, the rooms are cooled by storing the heat in the entire building, as expected primarily in the ceiling. Ideally, heat is discharged from the ceiling through free cooling. The ceiling is cooled throughout the entire duration of a hot spell and correspondingly heats up slower and to a lesser degree. This not only has a very positive effect on the room climate, but on the heat sink as well. The heat sink is charged very slowly in synch with the activated concrete ceiling. The temperature level of the heat carriers is significantly reduced, which prevents overstrain if the heat sink is appropriately dimensioned. The storage capacity and storage potential of the building-heat sink system is greatly increased by this consideration.

Timely temperature decrease creates additional potential for heat absorption during hot spells. >>

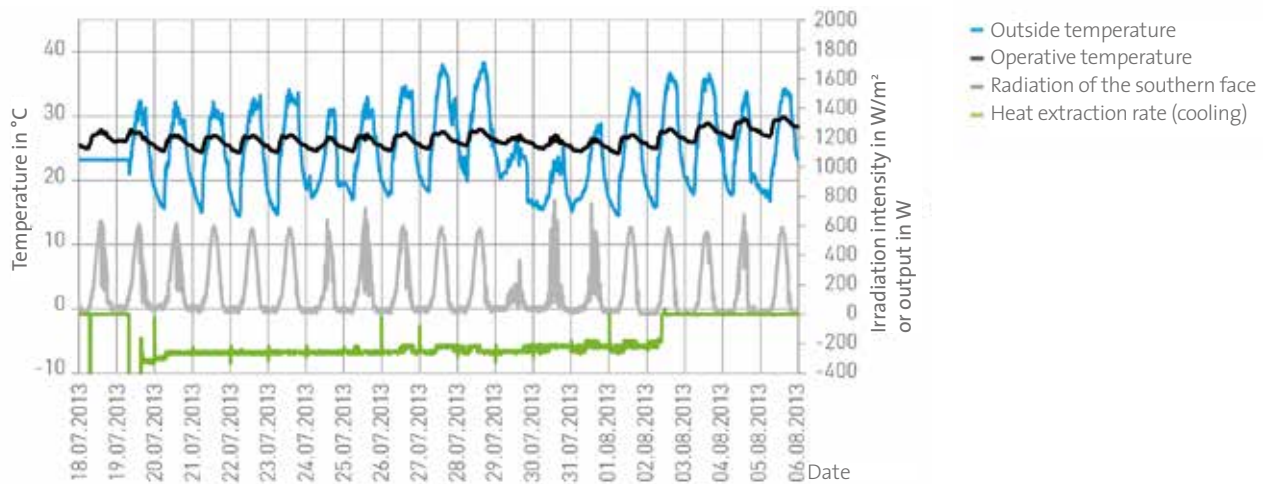

Fig. 29 | Simulation room at Innovations- und Forschungsstelle Bau, Salzburg, Austria: Temperature and output drawings in the research period. Despite switching off the cooling on 2. 8. 2013, the operative temperature does not rise rapidly.

© ARGE Nachhaltige BAUTEILAktivierung

For practical implementation, it is necessary to provide an additional switch, the so-called "summer mode", in the system control. The major difference from normal operation ("winter mode") is in the definition of a sensible temperature band of the activated concrete ceiling and in corresponding programming of the system control for the switch-on and switch-off processes of the circulation pumps. In summer mode, the room temperature is controlled by the signals of the sensors in the activated ceiling. The temperature band of the activated ceiling is narrowed. The lower limit is raised slightly and defined at e.g. 23 °C, the upper limit is pushed downwards and defined at e.g. 24 °C. The system control is programmed so that the circulation pump is activated when 24 °C is reached and switched back off when the lower limit of 23 °C is reached. If more heat enters the building than can be discharged through the ceiling, the building warms up slowly. During long hot spells, the desired room temperature can be exceeded for short periods of time. This is connected with high outside temperatures by nature. However, the comfort criteria are still upheld.

In addition to the easily-comprehensible standard framework conditions, the possible effects of any individual influencing factors on the TCA system control should not be overlooked. Both the user and the thermal behaviour of the building could be affected by this. It is very wise to check the installed system control regarding possible optimisations after a sufficiently long period.

Practical implementation of summer mode

Optimisation of the system control is recommended after a run-in period

Basis for planning

The following will handle the special features of the planning of thermally-activated ceilings in more detail. In addition to the list of planning recommends, the required planning steps will be handled chronologically.

Calculation of heat load of considered space

The heat load of considered space must be calculated in the first step as the foundation for the design of the effective heat exchanger surface. As already mentioned, the results of the calculation for heat load in accordance with standards ÖNORM EN 12831 and ÖNORM H7500-1 cannot be used due to the overly high security and the resulting oversizing for low-energy and passive houses. Until a design heat load exists for thermal high-quality buildings (ÖNORM H7500-2; in the project stage), taking the path for calculation for heat load of the Passive House Planning Package (PHPP) is recommended.

No applicable ÖNORM, first calculation by means of the Passive House Planning Package (PHPP)

The main differences between the calculation for heat load according to the PHPP and a standard-compliant calculation for heat load are listed below in keywords and explained:

Four arguments for using PHPP

1. PHPP sets higher outside air temperatures

REASON:

Highly insulated buildings react slowly to extreme winter conditions. The standard approach of using short cold periods (2 days) as a scale for the design temperature is not sensible for highly insulated buildings. Longer cold periods, however, do not occur nearly as often. Since the selection of the outside air temperature for a calculation for heat load is always connected to the probability of this temperature occurring at the building site, much higher outside temperatures are set in accordance with the PHPP as specified in the currently valid standard.

2. PHPP takes into account the effect of heat sources in building interiors

REASON:

Even small amounts of inside heat have a big effect on the inside temperature of highly-insulated buildings. The (standard-compliant) negligence of all inside heat leads to an overly high heat load and to security that is much too high for low-energy houses. PHPP does not ignore the inside heat, but consciously sets it very low to be on the safe side.

3. PHPP does not set thermal bridge correction factors

REASON:

According to ÖNORM EN 12831, all U-values are increased by at least $0.05 \text{ Wm}^{-2}\text{K}^{-1}$ within the framework of an estimated consideration of thermal bridges. If there is an outer wall of passive house quality ($U=0.1 \text{ Wm}^{-2}\text{K}^{-1}$), this means that the thermal bridge correction factor of 50% is much too high. However, thermal bridge correction factors are much below 10% if detailed planning is adequate. For passive houses, the thermal bridge correction factor must be less than or equal to zero (0% factor). The term "thermal bridge-free" is often used in this context.

4. PHPP expects small air change rates

REASON:

According to ÖNORM EN 12831, in principle the calculation for heat load is to be done assuming a 0.5-time air change. In the PHPP, the fresh air supply, on the other hand, is derived from use - and particularly the occupancy. In normally-used rooms, this leads to a much lower air change rate. It must be noted in this context that high air change in deep winter causes very dry air. The reduction in the air change rate in the calculation for heat load according to the PHPP is rooted, among other things, in the requirement that very good air tightness of the building envelope must be ensured in passive houses. A so-called blower door test is used to verify that this goal has been reached. Such measurements are not complex and can bring about great benefits due to their potential for early detection of imperfections in the building envelope. At any rate, the execution of such tests is recommended for all current new buildings.

Excessive air change rate in deep winter results in very dry inside air. >>

Calculation for heat load of a model room

Key figures of the model room according to section. III.1 of the "Energy-storage concrete" study (see bibliography, page 117) at the Eisenstadt building site

Key model room figures

Net area:	35.0 m ²
Headroom height (HH):	2.90 m / net volume: 101.5 m ³
Storey height (SH):	3.35 m ²
Building site:	Eisenstadt

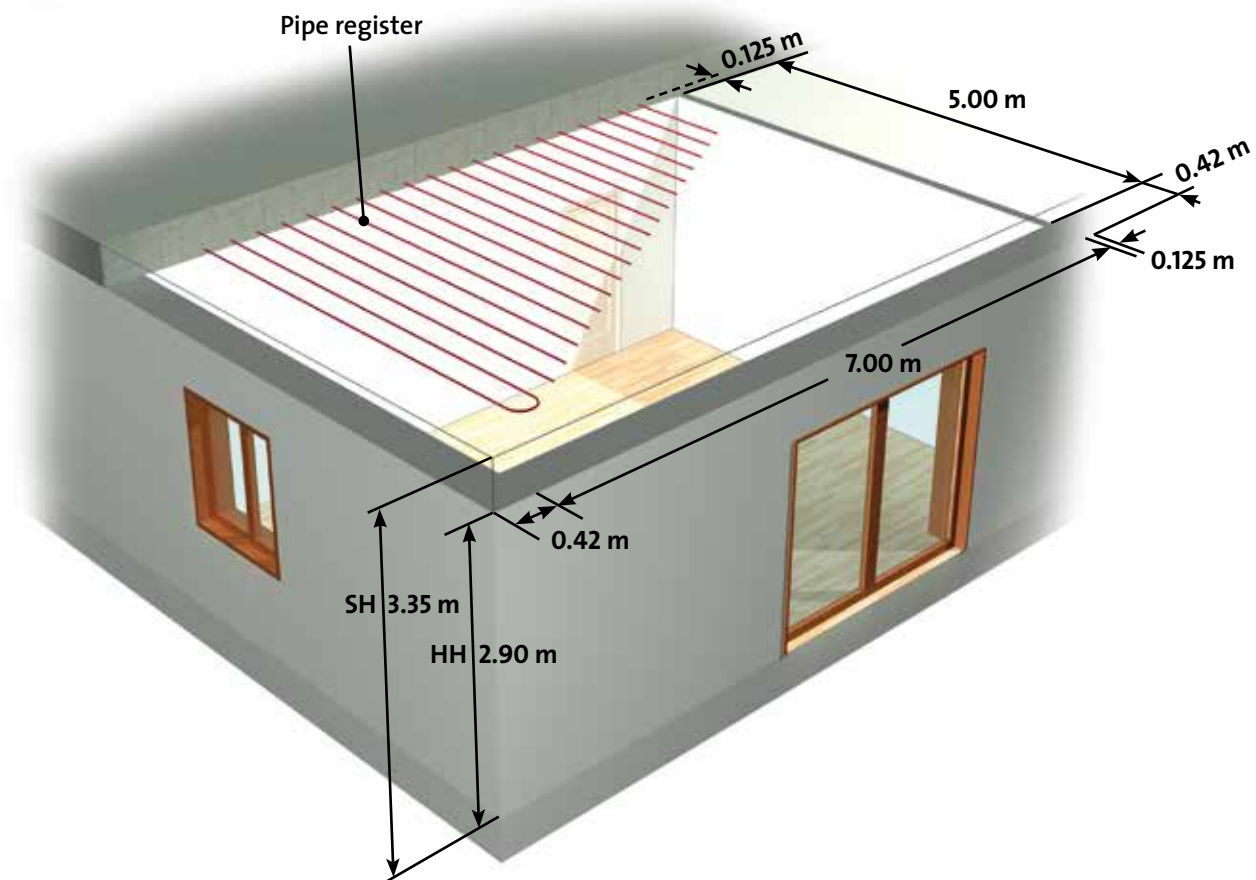

Fig. 30 | 3D representation of the model room © Z+B

Component list (outside components)

		U value [Wm ⁻² K ⁻¹]
Exterior wall	20 cm STL disc with 20 cm TICS outside	0.15
French door, west	Triple heat protection glass with wood frame	0.87
Window, north	Triple heat protection glass with wood frame	0.87

Surface calculation for the outside components

Outside dimensions are to be used for surface calculation for the calculation for heat load.

When calculating the wall areas of the model room, half the thickness of the partition wall (0.125 m) is to be included in the calculation:

Ceiling height 3.35 m · (width 5.00 + 0.42 + 0.125/2 m + length 7.00 + 0.42 + 0.125/2 m) = 3.35 · 12.965 = 43.43 m²

	Area [m ²]
Exterior wall surface	35.77 m ²
French door, west	5.77 m ²
Window, north	1.89 m ²
Sum of façade areas	43.43 m ²

Calculation of thermal transmission conductance | L_T

L_T
Thermal transmission
conductance

The partial thermal conductance values are to be calculated as the product of the U-value and associated component areas and added up.

Area [m²] · U-value [Wm⁻²K⁻¹] = thermal conductance [WK⁻¹]

	Area [m ²]	U value [Wm ⁻² K ⁻¹]	Thermal conductance [WK ⁻¹]
Exterior wall	35.77	0.15	5.366
French door, west	5.77	0.87	5.020
Window, north	1.89	0.87	1.644
			12.030

The thermal conductance of wall openings is higher than that of the outer wall!

The transmission heat losses through the outside wall are therefore lower than those through French doors and windows, even though the passive house standard is assumed for these components! >>

Consideration of thermal bridges is only possible as an estimation in the early planning phases. High-quality detailed planning regarding the prevention of overly high heat losses in areas of component connections is assumed here. The thermal transmission conductance is only increased by 5%, i.e.

$$L_T = 1.05 \cdot 12.030 = \mathbf{12.63 \text{ WK}^{-1}}$$

Calculation for heat load according to the PHPP

According to the PHPP, the heat load is calculated both for a cooler day with high solar radiation and for a warmer but cloudy day. The higher value is considered the heat load. In the present case, the heat load refers to a cloudy day.



Climate data for the calculation for heat load

The climate data for the calculation for heat load is taken from PHPP for the Eisenstadt site as follows:

Standard outside temperature	-4.4 °C (according to PHPP)
Indoor set temperature:	22.0 °C (assumption or user wish)

1. Calculation of transmission heat losses | Φ_T

The **heat losses** result in

$$\Phi_T = L_T \cdot (\text{set temperature} - \text{outside temperature})$$

$$\Phi_T = 12.63 \cdot (22 - (-4.4)) = \mathbf{333.4 \text{ W}}$$

Φ_T
Transmission heat loss

L_T
Thermal transmission conductance

2. Calculation of ventilation heat loss | Φ_V

a) Room volume

The volume relevant for the air change is a result of the product of the living area and headroom height of

$$V = \text{living area} \cdot \text{headroom height} = 35.0 \cdot 2.90 = \mathbf{101.5 \text{ m}^3}$$

Φ_V
Ventilation heat loss

V
Room volume

L_V
Thermal ventilation conductance

b) Thermal ventilation conductance

Assumption: 0.3-time air change

air volume flow = $101.5 \cdot 0.3 = 30.45 \text{ m}^3\text{h}^{-1}$ (minimum value according to PHPP)

thermal ventilation conductance: $L_V = 0.34 \cdot 30.45 = \mathbf{10.35 \text{ WK}^{-1}}$

NOTE:

The presence of a ventilation system with heat recovery is not assumed here. The factor 0.34 is the volume-related specific thermal capacity of the air and was taken from ÖNORM B8110-6.

Φ_V
Ventilation heat loss

L_V
Thermal ventilation
conductance

Θ_i
Set temperature of the room

Θ_e
Outside air temperature

Φ_I
Total heat loss

Φ_T
Transmission heat loss

Φ_V
Ventilation heat loss

c) Ventilation heat loss

The ventilation heat loss results in

$$\Phi_V = L_V \cdot (\Theta_i - \Theta_e) = 10.35 \cdot (22 - (-4.4)) = \mathbf{273.2 \text{ W}}$$

3. Calculation of total heat loss | Φ_I

The heat losses of the building under design conditions are the result of the sum of the transmission and ventilation heat loss of

$$\Phi_I = \Phi_T \text{ transmission heat loss} + \Phi_V \text{ ventilation heat loss}$$

$$\Phi_I = \Phi_T + \Phi_V = 333.4 + 273.2 = \mathbf{606.6 \text{ W}}$$

4. Calculation of heat input in the room | Φ_g

Heat gains inside the building set in due to building use and sun radiation through the windows. In contrast to the standard-compliant calculation for heat load, the effect of the heat input is not ignored here.

Φ_g
Total heat gain

Φ_i
Occupancy
sensible gain

Φ_S
Solar gain

I
Solar irradiation intensity

A_w
Area of the windows and
glazed doors
(including frame)

g
Solar heat gain coefficient
("g value") of the glass

r
Reduction factor

a) Occupancy sensible gain | Φ_i

A heat output by living area of 1.9 W/m² is set (according to PHPP). This includes all heat outputs caused by occupancy, lighting and the operation of devices.

The usage-dependent heat output results in

$$\Phi_i = 1.9 \cdot \text{living area}$$

$$\Phi_i = 1.9 \cdot 35 = \mathbf{66.5 \text{ W}}$$

b) Heat gain due to sun radiation | Φ_S

Solar irradiation intensity: $I = 10 \text{ W/m}^2$ (for both the west and the north façade; according to PHPP for cloudy weather at the Eisenstadt site)

	A_w [m ²]	g	r	I [Wm ⁻²]	Heat input [W]
French door, west	5.77	0.45	0.48	10.0	12.46
Window, north	1.89	0.45	0.65	10.0	5.53

$$\Phi_S = \mathbf{17.99 \text{ W}}$$

NOTE:

The **solar heat input** is calculated according to

$$\Phi_S = A_W \cdot g \cdot r \cdot I$$

Solar heat gain coefficient ("g value"):

In addition to the U-value U_g of the glass, the g-value is the second most important parameter of the glazed part of the window or a French door. The g-value specifies how large the share of the sun radiation hitting the outside of the glass is which becomes effective as heat output after passing through the glass into the interior or the room. The solar heat gain coefficient is part of the production declaration of the glass.

Reduction factor r is between 0 and 1 and reduces the g-value of the glass. According to PHPP, this following influences are taken into account by this:

- Since A_W is the entire window area, it must be multiplied times the glass percentage of the window
- Contamination of the glass when installed reduces the amount of radiation
- Less radiation passes through when the sun radiation hits the glass at an angle
- Any shading effects are considered as a lump sum

Reduction factor r is automatically calculated by PHPP due to the window inputs and the window orientation.

c) Total heat input | Φ_g

The entire heat input in the room is:

$$\Phi_g = \Phi_i + \Phi_S = 66.5 + 17.99 = \mathbf{84.5 \text{ W}}$$

Φ_g
Total heat gain

Φ_i
Occupancy sensible gain

Φ_S
Solar gain

5. Calculation of heat load of considered space | Φ_{HL}

Heat load of considered space:

$$\Phi_{HL} = \Phi_l - \Phi_g = 606.6 - 84.5 = \mathbf{522 \text{ W}}$$

The heat load related to the net area of the room is

$$\frac{522}{35} = \mathbf{14.9 \text{ Wm}^{-2}}$$

Φ_{HL}
Heat load
of considered space

Φ_l
Total heat loss

Φ_g
Total heat gain

Calculation of the effective heat exchanger surface | A_R

Heat output by treated floor area q not higher than 25 W/m^2

A_R
Effective heat exchanger surface

$A_{R,\min}$
Minimum required effective heat exchanger surface

Φ_{HL}
Heat load of considered space

q
Heat output by treated floor area (TFA)

q_{\max}
Maximum heat output by treated floor area (TFA)

Using the **heat load of considered space** Φ_{HL} (in watts), the **minimum required effective heat exchanger surface** $A_{R,\min}$ (in m^2) for covering this heat load can be easily calculated if the **maximum heat output by treated floor area** of the **thermally-activated ceiling** q_{\max} (in W/m^2) is known:

$$(4) \quad A_{R,\min} \approx \frac{\Phi_{HL}}{q_{\max}}$$

As already mentioned, q_{\max} should not be set larger than 25 W/m^2 in order to ensure very high thermal comfort in the room even under very unfavourable outdoor climatic conditions.

An initial rough estimation can be done in the very early planning phases by taking into account equation (4). A comparison of the required effective heat exchanger surface $A_{R,\min}$ with the ceiling area available for thermal activation immediately shows whether heating the room solely by thermal activation is possible or not.

With the heat load of considered space of 522 W (from section 5, page 73) the minimum required effective heat exchanger surface according to equation (4) results in

$$A_{R,\min} = \frac{522}{25} = \mathbf{20.9 \text{ m}^2}.$$

This is about 60% of the ceiling area. Sole heating by thermally-activated ceiling is therefore very possible for this room.

Determining ceiling areas available for TCA

Normally, the ceiling area available for activation coincides with the net area of the room. Of course, consultation with the structural engineer must be done to determine which parts of the ceiling areas must not be overlaid with registers. In addition, it is important to know that the thermal activation of the ceiling can only be used wisely to control the temperature of a room if no layers with thermal insulation are located between the pipe register and the space under the ceiling. Areas with suspended ceilings, but also areas in which the ceiling soffit is equipped with sound-absorbing material, are therefore not available for thermal activation.

Estimation of the required effective heat exchanger surface

If the rough estimation of the minimum required effective heat exchanger surface according to equation (4) leads to the conclusion that heating the building is possible solely with thermal activation of the ceiling, it is necessary to more

precisely define the effective heat exchanger surface. This definition correlates closely with **heat output by treated floor area** q of the thermally-activated ceiling. With a very good approximation, q is proportional to the difference of the **temperature of the heating medium in the pipe** Θ_r and the **set temperature in the space under the ceiling** Θ_u . The following therefore applies:

$$(5) \quad q = \Lambda_{r,u} \cdot (\Theta_r - \Theta_u).$$

A thermal conductance value is used to calculate the heat flow through a component between two rooms and has dimension WK^{-1} . The heat flow is always the result of multiplication of the thermal conductance with the temperature difference between the two rooms.

In this context, rooms are not only the inside rooms of a building, but also those areas to whose temperature a fixed value can be assigned. The outer surroundings of a building can therefore be called a room (outside room). The respective set temperature is fixed for the inside rooms of the building for the calculation for heat load. The design temperature is defined for the outside room. The inner pipe is also considered a "room" for TCA, and an average temperature of the heating and cooling medium can be assigned to it.

Thermal conductance by treated floor area is present if the thermal conductance is divided by the surface area of a reference surface. Its dimensions are therefore $\text{Wm}^{-2}\text{K}^{-1}$. The best-known example for such thermal conductance by treated floor area is the thermal transmittance (U-value) of a plate-shaped component.

In a special TCA case, the thermal conductance between the pipe register and the room to be heated is interesting. This thermal conductance can be determined through multivariate calculation of the heat flow and is specified in the form of thermal conductance by treated floor area. The effective heat exchanger surface is used as the reference surface here. If the **thermal conductance by treated floor area** $\Lambda_{r,u}$ is known, the **heat output by treated floor area** of the thermally-activated ceiling q can be calculated by hand for any combination of set temperature and the temperature of the heating medium in the pipe.

The magnitude of factor $\Lambda_{r,u}$ depends on several parameters such as the distance between the ceiling soffit and the pipe register, the axial spacing of the pipes in the register, the tube diameter, etc.

ASSUMPTION:

The pipe register has a 5 cm concrete cover

Normally, the pipe register lies on the lower reinforcement of the ceiling and is about 5 cm from the ceiling soffit; the "concrete cover" of the pipe register is therefore 5 cm. Only this case is to be handled in the following. The diameter of the pipes has a comparatively small influence on $\Lambda_{r,u}$ and is therefore defined as 17 mm (outer diameter).

Thermal conductance by treated floor area (TFA) | $\Lambda_{r,u}$

A thermal conductance value is used to calculate the heat flow between two rooms and has dimension WK^{-1} . <<

q

Heat output by treated floor area (TFA)

$\Lambda_{r,u}$

Thermal conductance by treated floor area (TFA)

Θ_r

Temperature of the heating medium in the pipe

Θ_u

Set temperature in the room under the ceiling

The dependency of the thermal conductance by treated floor area on the axial spaces of the pipes **d** was determined with numerical methods and leads to the following result.

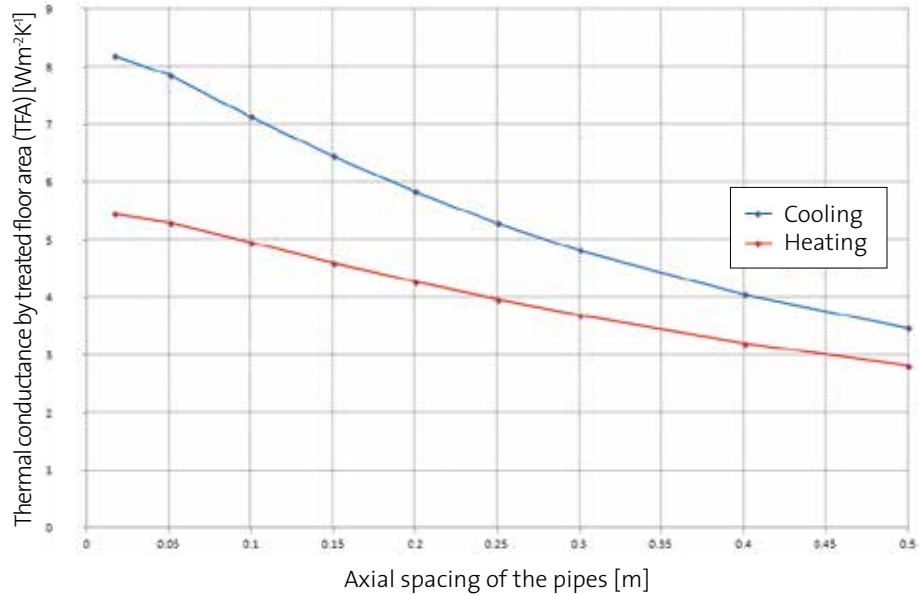

Fig. 31 | Dependency of the thermal conductance by treated floor area $\Lambda_{r,u}$ on the axial spacing of the pipes. © Klaus Kreč

$\Lambda_{r,u}$
Thermal conductance by treated floor area (TFA)
d
Axial spacing of the pipes

The two curves shown in Figure 31 can be described in good approximation with the formulation

$$(6) \quad \Lambda_{r,u} = a \cdot d^2 + b \cdot d + c$$

This has the advantage that $\Lambda_{r,u}$ can be calculated relatively easily by hand.

The parameters required for this calculation (**a**, **b**, and **c**) are listed for various constructional solutions in the "Energy-storage concrete" research report. For a 5 cm concrete cover and pipe with dimensions 17 x 2 mm and with an unplastered ceiling soffit, the following parameters are the result:

Table 3 | Coefficients in equation (6) for calculating $\Lambda_{r,u}$.
Pipe 17 x 2 mm; concrete cover 5 cm; exposed ceiling soffit

	a	b	c
Heating	4.53	-8.04	5.70
Cooling	12.20	-16.43	8.64

Parameters a, b, c taken from the "Energy-storage concrete" research report.

More detailed information on the function of activated concrete ceilings and the required parameters can be found in the following publication:

Kreč Klaus;
Forschungsprojekt
Energiespeicher Beton
Endbericht.
Vereinigung der Österr.
Zementindustrie, Wien, 2016
Download:
www.zement.at/
services/publikationen/
energiespeicher-beton >>

If $\Lambda_{r,u}$ is known, both the heat output by treated floor area q in accordance with equation (4) and the effective heat exchanger surface according to

$$(7) \quad A_R = \frac{\Phi_{HL}}{q}$$

can be calculated by hand for different combinations of temperatures Θ_u and Θ_r .

The **average surface temperature Θ_s of the ceiling soffit** of a thermally-activated ceiling can be easily calculated by hand with relation

$$(8) \quad \Theta_s = \Theta_u + \frac{q}{\alpha}$$

α is the surface coefficient of heat transfer for the ceiling soffit. For heating, $\alpha = 6.5 \text{ Wm}^{-2}\text{K}^{-1}$. For cooling, α is to be set as $10.8 \text{ Wm}^{-2}\text{K}^{-1}$ and heat output by treated floor area q is to be inserted into equation (8) with a negative sign.

A_R
Effective heat exchanger surface

Φ_{HL}
Heat load of considered space

q
Heat output
by treated floor area (TFA)

Θ_r
Temperature of the heating
medium in the pipe

Θ_u
Set temperature in the
room under the ceiling

Θ_s
Average surface temperature
of the ceiling soffit

α
Surface coefficient
of heat transfer

If initially a common standard with a pipe dimension of $17 \times 2 \text{ mm}$, a pipe spacing of 15 cm and a concrete cover of 5 cm are assumed, the thermal conductance by treated floor area according to equation (6) results in

$$\Lambda_{r,u} = a \cdot d^2 + b \cdot d + c = 4.53 \cdot 0.15^2 - 8.04 \cdot 0.15 + 5.7 = \mathbf{4.6 \text{ Wm}^{-2}\text{K}^{-1}}$$

With a set temperature in the heated room of $\Theta_u = 22 \text{ }^\circ\text{C}$ and an initially assumed temperature of the heating medium in the pipe of $\Theta_r = 27 \text{ }^\circ\text{C}$, the heat output per treated floor area according to equation (5) results in

$$q = \Lambda_{r,u} \cdot (\Theta_r - \Theta_u) = 4.6 \cdot (27 - 22) = \mathbf{23 \text{ W/m}^2}$$

The heat output per treated floor area is therefore under the upper limit of 25 W/m^2 . This means that at full capacity - meaning with the worst outdoor climatic conditions - it is enough to supply the register with temperatures of the heating medium of about $27 \text{ }^\circ\text{C}$.

The effective heat exchanger surface in this case according to equation (7) with

$$A_R = \frac{\Phi_{HL}}{q} = \frac{522}{23} = \mathbf{22.7 \text{ m}^2}$$

is somewhat larger than the minimum required effective heat exchanger surface $A_{R,\min}$. The average surface temperature of the ceiling soffit at full capacity with

$$\Theta_s = \Theta_u + \frac{q}{\alpha} = 22 + \frac{23}{6.5} = \mathbf{25.5 \text{ }^\circ\text{C}}$$

is only 3.5 K above the set temperature.

High thermal comfort is therefore also ensured at full capacity.

Calculation of the effective heat exchanger surface for the model room

$\Lambda_{r,u}$
Thermal conductance
by treated floor area (TFA)

d
Axial spacing of the pipes

A_R
Effective heat exchanger
surface

$A_{R,\min}$
Minimum required
effective heat exchanger
surface

Large effective heat exchanger surfaces increase room comfort

Oversizing the thermally-activated areas is not only harmless; it increases the thermal comfort in the room by sinking the surface temperature of the ceiling soffit. >>

Influence of the pipe distance

NOTE:

Under "normal" winter conditions, the heat output of the thermally-activated ceiling required for the room heating is much lower, which leads to surface temperatures just above the set temperature.

If the entire ceiling surface of 35 qm is available for thermal activation due to the constructional conditions ($A_R = 35 \text{ m}^2$), the heat output by treated floor area to be delivered under design conditions is calculated according to

$$q = \frac{\Phi_{HL}}{A_R} = \frac{522}{35} = \mathbf{14.9 \text{ W/m}^2}.$$

This heat output sets in at a temperature in the pipe of

$$\Theta_r = \Theta_u + \frac{q}{\Lambda_{r,u}} = 22 + \frac{14.9}{4.6} = 22 + 3.2 = \mathbf{25.2 \text{ }^\circ\text{C}}$$

with unchanged assumptions regarding the type and position of the pipe register according to (converted) equation (5).

At the same time, the average surface temperature of the ceiling soffit under design conditions sinks to

$$\Theta_s = \Theta_u + \frac{q}{\alpha} = 22 + \frac{14.9}{6.5} = \mathbf{24.3 \text{ }^\circ\text{C}}.$$

The question of whether the pipe spacing can be increased, thereby saving money, at an effective heat exchanger surface of $A_R = 35 \text{ m}^2$ can be answered quickly with a calculation by hand:

At a heat output by treated floor area of $q = 14.9 \text{ Wm}^{-2}$ and the assumed temperature of the heating medium in the pipe of e.g. $\Theta_r = 26 \text{ }^\circ\text{C}$, the required temperature band by treated floor area is calculated as

$$\Lambda_{r,u} = \frac{q}{\Theta_r - \Theta_u} = \frac{14.9}{26 - 22} = \mathbf{3.7 \text{ Wm}^{-2}\text{K}^{-1}}.$$

Figure 31 shows that this value is reached when the axial spacing of the pipes is defined at about 30 cm. A control calculation using equation (6) confirms that pipe spacing (d) can be increased to 30 cm ($\Lambda_{r,u} = 3.696 \text{ Wm}^{-2}\text{K}^{-1}$ at $d = 0.30 \text{ m}$).

Requirements on the building envelope

If a building is to be heated solely by thermal activation of the storey ceilings, it must be ensured (as shown) that the sum of the floor areas available for activation is larger than the minimum effective heat exchanger surfaces required for heating the building. If this is not the case, the heat loads of considered space - and therefore the total heat load - are reduced according to equation (4). The starting points for reaching this goal can be found directly in the calculation for heat load (see page 71 and 101).

The dimensions used in the calculation for heat load, which can be influenced by the designer, are the thermal transmission conductance, the thermal ventilation conductance and the solar heat recovery. Reducing the thermal transmission conductance and/or thermal ventilation conductance as well as increasing the solar heat recovery lead to the intended reduction in the heat load.

Influences on total heat load

> **Measures for decreasing the thermal transmission conductance**

As shown, the areas of individual components of the building envelope and their thermal transmittances (U-values) as well as factors for considering the increased heat flow in the area of the component connections ("thermal bridges") go into the calculation of thermal transmission conductance L_T . The intended decrease of L_T is possible due to increased heat insulation and the connected reduction of the U-values of the components of the building envelope, but also due to the reduction in component areas thanks to the transition to more compact building forms. In addition, careful detailed planning concerning the reduction of increased heat losses near the thermal bridges contributes to the decrease in thermal transmission conductance.

In the framework of increasing the thermal quality of the building envelope by means of improving the thermal insulation, it is effective to analyse the table of partial thermal conductance values (see examples on pages 70 and 100) regarding their magnitude. Of course, in such a case - in contrast to the "model room" example - the entire building or the entire building envelope must be taken into account. A larger effect is only achieved if those components whose partial thermal conductance values contribute to a larger percentage of the total thermal conductance are improved thermally. These are often doors and windows.

> **Foundation plate special case**

A special case in this context is the (not activated) lowest storey ceiling. If the building does not have a cellar, there is a foundation plate which, due to the thermal resistance of the soil, must be less insulated than the components exposed to air. If possible, the insulation should run under the foundation plate and pull up over the front side of the plate. When using foam materials, the insulation material thickness ranges from 15 cm to 20 cm and must natu-

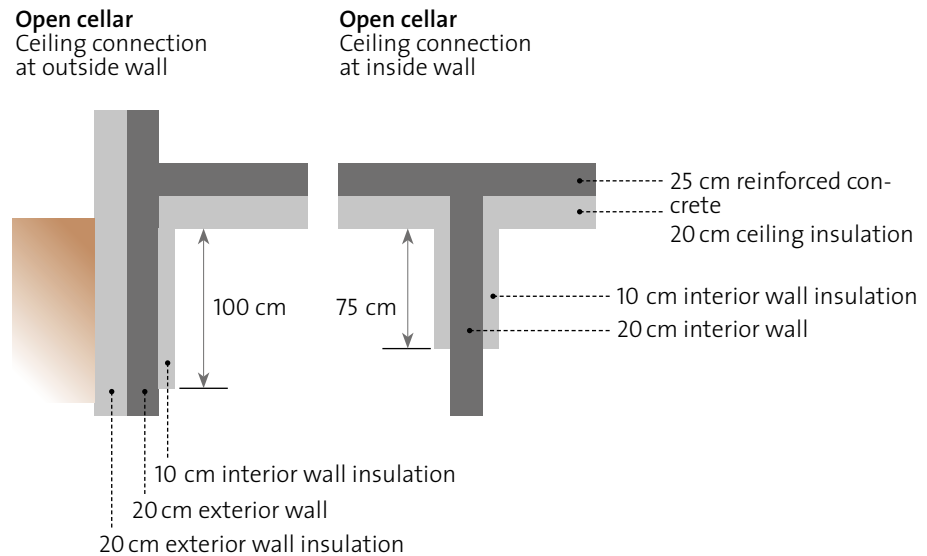

Fig. 32 | Design suggestion for open cellar, insulation with passive house standard, EPS insulating material with $\lambda = 0.031 \text{ W/mK}$, insulation on the ceiling soffit 20 cm. © Z + B

rally be adjusted to the thermal quality of the entire building envelope. The selection of ageing resistant materials is important in this context. If the insulating layer is in the groundwater, the layers must be stuck together.

> Cellar ceiling special case

If the building has a cellar and the cellar is not heated, it must be noted that a not inconsiderable part of the heat losses are created by thermal bridges in the area of the connections between the inside and outside walls on the cellar ceiling if the ceiling soffit is insulated. To prevent this, the insulation must be pulled down onto the walls from the ceiling. Parameter studies have shown that it is possible to end this insulation about one meter from the ceiling soffit if the insulation thickness is increased in turn. This result is significant concerning the usability of the cellar, for example as a parking garage. See Figures 32 and 33.

Note: Details on the parameter studies and the results can be found in the Forschungsprojekt Energiespeicher Beton Endbericht, Klaus Kreč, Vereinigung der Österr. Zementindustrie, Wien, 2016. See note on page 76.

> Measures for decreasing the thermal ventilation conductance

Whether measures for reducing the thermal ventilation conductance have a positive effect on the heat load is shown by a comparison of the thermal transmission conductance and thermal ventilation conductance in a first step. If, for example, the thermal ventilation conductance is only about half as large as the thermal transmission conductance, reducing the thermal ventilation conductance with possibly great effort only has a small effect.

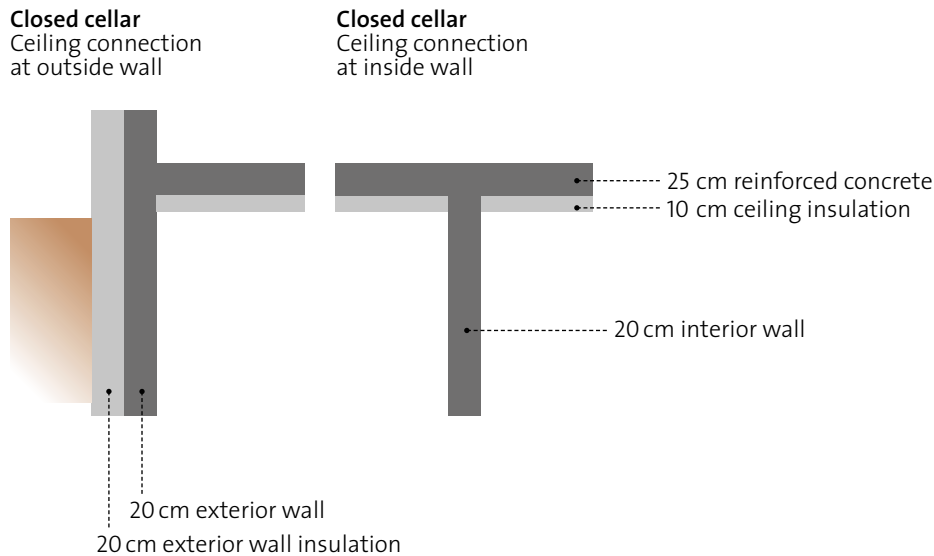

Fig. 33 | Design suggestion for closed cellar, insulation with passive house standard, EPS insulating material with $\lambda = 0.031 \text{ W/mK}$, insulation on the ceiling soffit 10 cm. © Z+B

In highly-insulated buildings, the thermal ventilation conductance is nearly the same or even higher than the thermal transmission conductance. In this case, providing a ventilation system with heat recovery can contribute much more to reducing the heat load than other more complex improvements of the thermal quality of the building envelope. With a heat recovery system for small-volume residential buildings, the thermal ventilation conductance can be reduced to at least 20% of its original value.

Decreasing the thermal ventilation conductance in highly-insulated buildings is very effective. <<

> Measures for increasing the solar gains

In the approaches for calculation for heat load according to the PHPP, only very low solar irradiation intensity values are used to be on the safe side. The optimisation of the solar gains only have a small effect on the reduction of the heat load for this reason. In this context, we must not lose sight of the fact that the increase in solar gains not only greatly reduces the heating demand - and thereby the operating costs - but also considerably increases living quality.

The solar gains are influenced by window size, the orientation of windows, the solar heat gain coefficient of the glass and any shading effects. When it comes to the variation in window size, it must be noted that, if the windows are increased in size, not only does the solar gain increase, but the transmission heat losses do as well. In the current design, only south-facing windows have a positive balance in the sense that the solar gains are larger than the transmission heat loss. East- and west-facing windows are generally balanced out, while increasing the size of north-facing windows reliably leads to an increase in the heat load and heating demand and is therefore counter-productive.

Optimising the solar gains requires intelligent planning. <<



Positioning of the pipe register

If, based on the results of the design calculations for the effective heat exchanger surface due to the requirements of the structural engineer or due to technical considerations of the building, the decision is made to thermally activate only parts of the ceiling of a room, the question immediately arises of where the heated ceiling parts could best be positioned.

The answer to this question depends heavily on the fact that the activated ceiling is a pure radiant heater. This consideration leads to the following planning recommendations:

- > Since the heat is transported by radiance, simple geometric considerations result in the statement that heated ceiling areas near the edges between the ceiling and the walls give off less heat than those in the centre of the ceiling.
- > The radiant heat transfer between the heated ceiling and all other inside surfaces of the room-adjacent components leads to temperature compensation. It is wise to take advantage of this effect and position the heated ceiling areas so that potentially cooled areas - almost always window areas - are heated up by the radiant heat transfer. The radiant heat transfer is only effective if the heated and cooled surfaces are at a favourable angle to each other. Simply speaking, the radiant heat transfer is high if hot and cool areas can "see each other well".
- > The radiant heat transfer naturally does not take place between the ceiling and the other room-adjacent components, but affects all objects in the room - e.g. furniture - as well as all people in the room. It is therefore clear that the position of the heated ceiling areas should be made dependent on the room heating. The position of the thermally-activated ceiling areas above areas like the dining room table or sitting area increase the thermal comfort in the room.

Of course, the planning recommendations outlined above can often not be completely upheld. The structural engineer's requirements will also have a large part in deciding on the positioning of the pipe register(s). As is so often the case, it is the task of the construction planner is to find compromises which adequately consider all aspects.

Position effective heat exchanger surfaces in good "visual contact" to cool surfaces. <<

Fig. 34 | left

The ceiling to be activated is overlaid in accordance with an installation diagram, typically on the lowest reinforcement layer or, for construction reasons, on a light construction steel mesh mat directly on the prefabricated ceiling.

© Aichinger Hoch- u. Tiefbau GmbH

Structure of the thermally-activated ceiling

Heat flow through the insulation can be "controlled"

The heat flow within the structure always takes the path of least resistance. >>

Heat always flows from areas of higher temperature to areas of lower temperature. >>

A significant requirement on the thermally-activated ceiling is that the predominant part of the heat given off from the ceiling during heating must go to the room under the ceiling. Similarly, a requirement on cooling operation is that mainly heat under the ceiling must be extracted. The following planning note results these two requirements from a building physics point of view:

- > Layers or structures with high thermal resistance on the ceiling soffit must be avoided since they can drastically decrease the heat of output of the thermally-activated ceiling. Ideally, the ceiling soffit near the thermally-activated areas will be made of exposed concrete or will only be thinly filled. If the ceiling soffit is plastered, a plaster with high thermal conductivity must be used. Acoustic plaster, which exhibits relatively low thermal conductivity due to its sound-absorbing effect, should be avoided. As already mentioned, suspended ceilings are not compatible with the concept of thermal component activation due to the shielding of the heat radiation from the room and are therefore not permitted under thermally-activated areas.
- > The embedding of the heat register into the steel concrete ceiling causes the heat from the register to be given off both downwards and upwards. The percentage of the heat flow moving upwards - in the "wrong" direction - of the total heat flow given off from the register is dependent on the thermal resistance of the construction above the steel concrete ceiling. Of course, different types of storey ceilings must be differentiated:

1. Ceiling between typical storeys

The floor structure should have thermally-insulating layers in addition to foot-fall sound insulation. This increases the thermal resistance and the heat flow moving upwards from the heating register is considerably decreased. If a 10 cm-thick insulation layer is installed, for example the heat flow moving upwards is reduced to a few percentages of the total heat flow.

2. Upper storey ceiling

The upper storey ceiling either borders an unheated attic or is built as a flat roof. In both cases, the ceiling must be very well insulated since otherwise, due to the low temperatures above the ceiling in winter, the heat flow moving upwards from the heating register will be too big. In this context, it must be pointed out that when planning the attic, particular attention must be paid to preventing large heat losses, meaning keeping the thermal bridge effect small.

3. Flat roof

If there is a flat roof, its must be considered that sun radiation on a horizontal or only slightly tilted surface is extremely high. The roofing heats up due to this sun radiation, which leads to heat input in the room under the ceiling and can lead to overheating or an increased need for cooling. The colour of the roof has a big influence on how large this undesired effect is in summer. If the roof

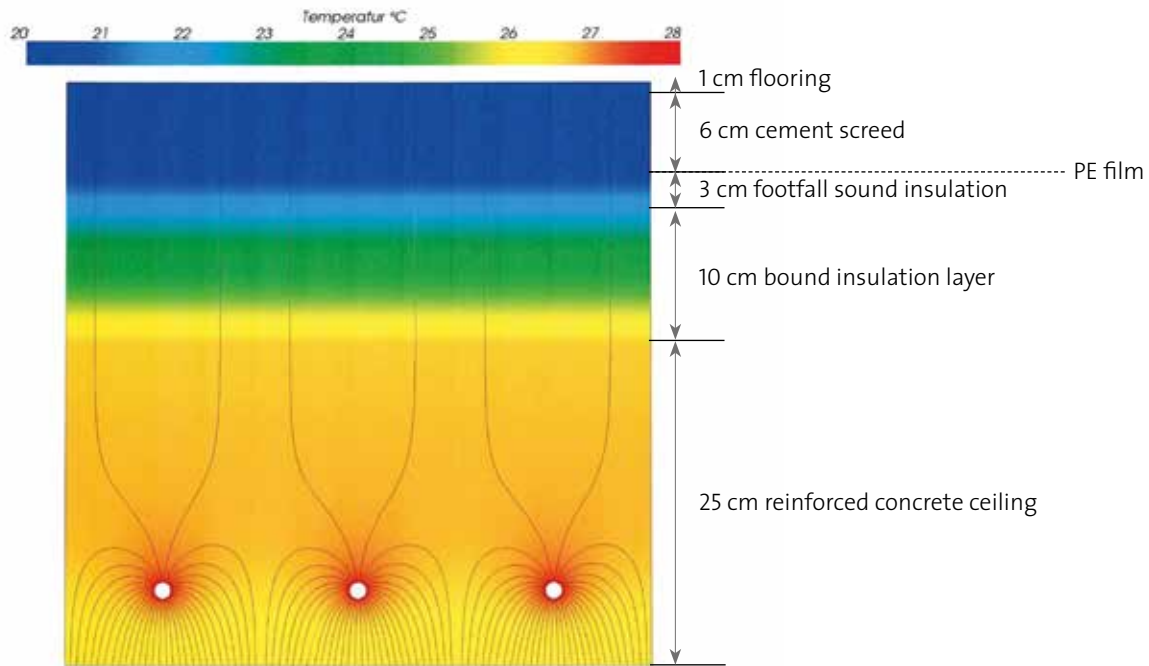

Fig. 35 | Diagram of the temperature distribution and heat flow lines; ceiling structure; heating: temperature of heating medium 28 °C; room air temperature 20 °C.
© Klaus Kreč

surface is dark, up to 90% of the sun radiation can be absorbed, which leads to very high surface temperatures and high heat input. If, on the other hand, the roof surface is light, a large part of the sun radiation is reflected and only about 30% of the radiation is absorbed. For heat input reasons, making the roofing of a flat roof as light as possible is recommended.

Application example

In the last few years, a number a buildings with component activation have been built all over Austria. In many cases, component activation is only used as a heat output or heat extraction system.

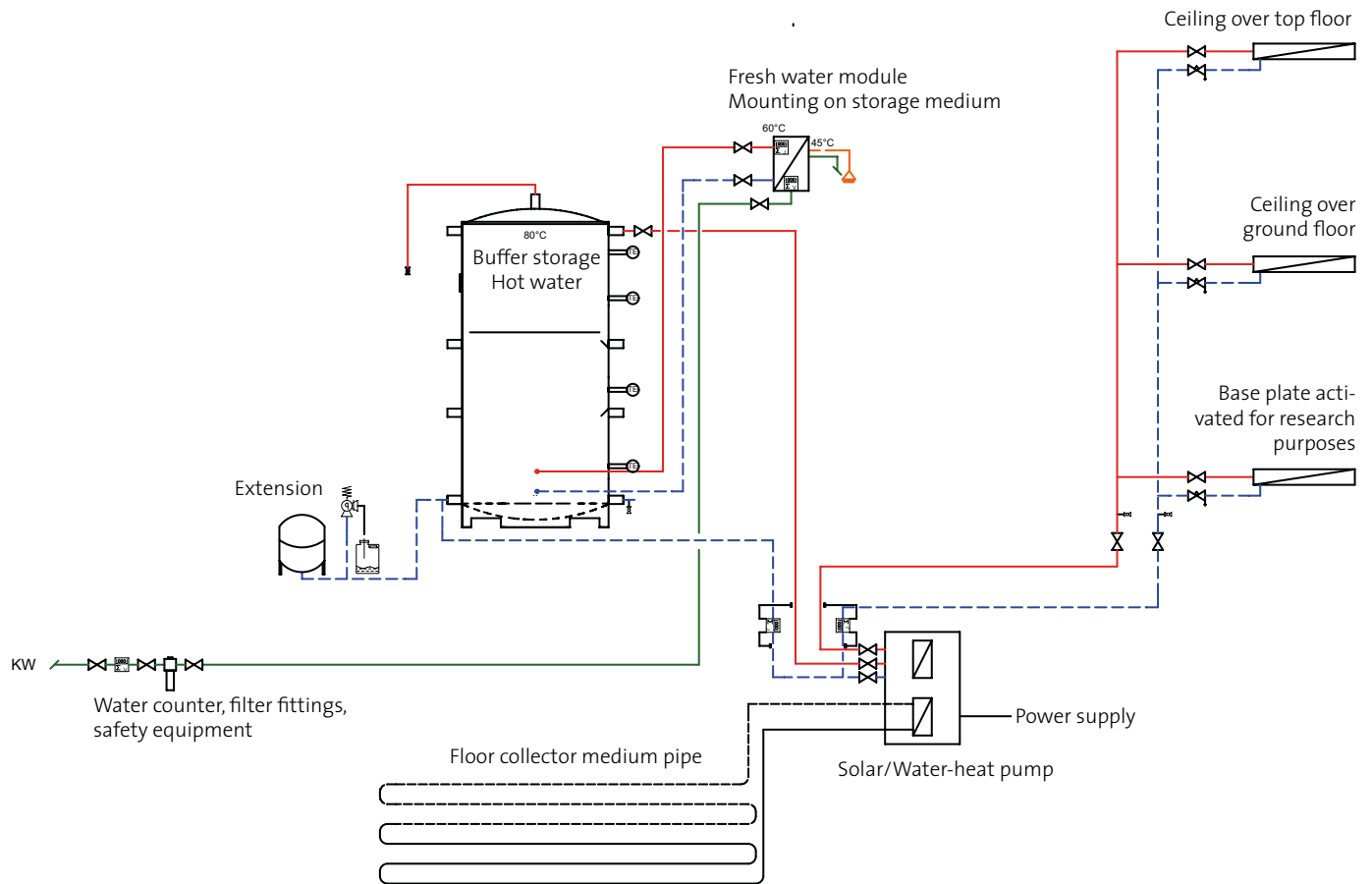

Fig. 36 | Model house schematic diagram, diagram – heating, draft.

© FIN – Future Is Now, Kuster Energielösungen GmbH

System variant 3 executed

In order to optimally utilise the potential of TCA, the high heat capacity of concrete is used to increase the share of renewable energy in the entire energy consumption of a building. Previously implemented projects were usually based on the PV-heat pump-TCA or solar thermal energy-TCA combination.

A recently-built single-family house is used to explain the most important steps in creating an activated storey ceiling. A special feature is that the heat pump is supplied by the public grid with excess power from the production of a wind park. A surplus is defined as that share of production over 30% of the nominal output of the wind park. The surplus power is available when the wind park operator releases it for use. The building described below was built in Lower Austria in 2016. The building envelope is built in accordance with the passive

**Supply of a heat pump
with surplus energy from
wind park production**

house standard. In addition, the heat demand is further reduced by installing a ventilation system with high-efficiency heat recovery. Besides a connection to the public power grid, no other connections to power supplies exist. The heat is supplied via a solar-water-heat pump. The required ground collector is laid at a depth of 1.2 m and is 2x100 m long with an installation distance of 0.6 m. The resulting collector area is therefore 120 m².



Fig. 37 | Application examples of ground collectors.

© FIN – Future Is Now, Kuster Energielösungen GmbH

The nominal heat output of the heat pump was selected to be 6 kW and thereby purposely oversized in order to store as much energy as possible in the building during short wind power release times. The heat pump is used for the domestic hot water supply and room heating. A water-based heat accumulator is not provided for the room heating. The heat pump is directly connected to the activated concrete components. Buffer storage is used as a heat accumulator for the domestic hot water supply. The required hot water is warmed up with the continuous flow principle via a fresh water station. The buffer storage volume is set at 1000 l in order to store enough energy to cover the hot water needs for several days. The thermal activation of the ceiling between the ground and top floor is done via three heating circuits installed on a prefabricated ceiling. Four heating circuits are implemented in the upper storey ceiling. The uniform installation distance of the pipelines is 25 cm. Smaller distances are selected in order to achieve higher temperatures in the wet rooms than in the rest of the building. No cooling is provided for this application example.



Fig. 38 | top

The installation distances chosen in wet rooms are smaller than in the living area.

© Aichinger Hoch- u. Tiefbau GmbH

Fig. 39 | right

The temperature sensor is installed at the level of the pipe register.

© Aichinger Hoch- u. Tiefbau GmbH



The foundation plate is also equipped with TCA in the example provided. This additional equipment, which is typically not necessary, is installed for research purposes.

The heat pump is controlled by the temperature sensor (see Figure 39). Sensors in the concrete components prevent overheating of the storage masses during the charging processes. Sensors in the rooms report the current room temperature values to the TCA system control.

The drive energy for the heat pump should come from wind power production surpluses to the greatest extent possible. The wind release phases are reported to the building control system by the energy supplier via a remote signal. The TCA system control is programmed so that electric energy is only obtained from regular energy production when this is absolutely necessary. The building is kept a slightly increased temperature level during the release times. The energy stored in this way is used to bridge long periods of time without wind power release.

Interdisciplinary collaboration

The use of components as storage mediums for the technical building system requires optimised interaction between structural engineers and in-house technicians. Interdisciplinary collaboration between master builders and installers is essential, both in planning and during implementation. While component structures are usually defined by structural engineers and in-house technicians, only use the finished component structures as a foundation for dimensioning their systems, the in-house technicians are involved in the planning of activated buildings to help define the structures. After all, the components are the storage media of the technical building equipment.

A so-called prefabricated ceiling is used in the application example. A layer of in-situ concrete is applied after all laying and installation work is completed.

The first step in producing the ceiling is the installation of the reinforced finished parts according to the plan. They are positioned on the previously-built masonry or a load-supporting base with a crane in accordance with the specifications of the structural engineer.

The pipelines for TCA are installed on the concrete board in accordance with the specifications in the installation plans. Thin strips made of construction steel mesh mat are laid between the lattice beams to fix the pipelines correctly in layers. This is not done for static purposes, but for purely practical construction reasons. The easiest way to fasten the component activation pipelines to the cropped steel mats is with cable clips. This fastening is necessary to prevent unwanted layer changes during concrete work.

A minimum level of understanding for the other trades is a prerequisite for an good project schedule from the development of the concept to completion. >>



Fig. 40 | top

Implementation of the in-situ concrete ceiling: The pipelines are typically mounted in the lowest reinforcement layer.

© Thomas Schönbichler/CL

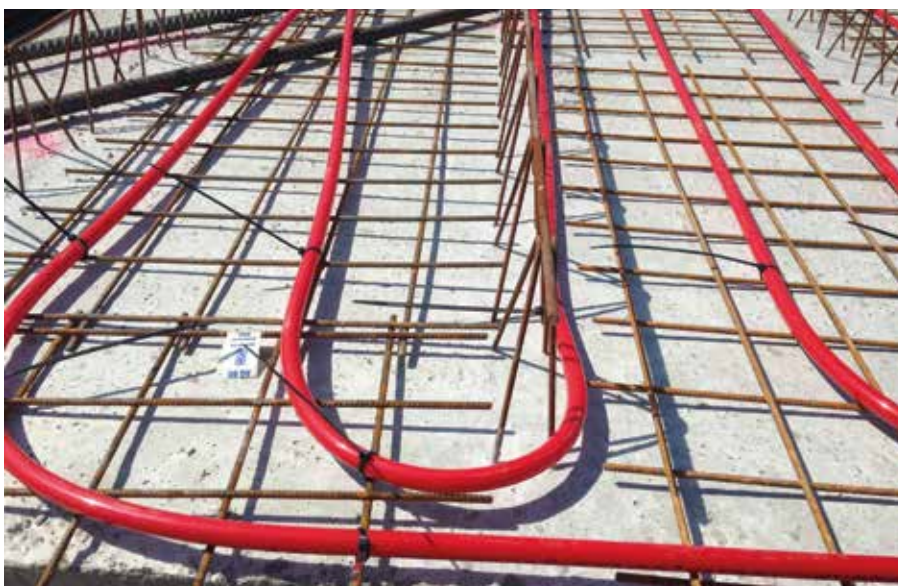

Fig. 41 | left

Implementation of the prefabricated ceiling: The pipelines are fastened directly on the prefabricated ceiling on a construction steel grate.

© Aichinger Hoch- u. Tiefbau GmbH

If the ceiling is not a prefabricated ceiling but an in-situ concrete ceiling, the pipelines are generally fastened on the lower reinforced layer with cable clips. The determination of the position of the pipes is agreed upon in consultation with the structural engineer.

The installation distances and routing of the pipelines are determined during planning and defined in an installation plan. This includes all information necessary for the proper installation of pipelines including all connections and installations. The pipelines are typically cut to length from endless tubes. Dividing up pipelines throughout the heating circuit should be avoided. The necessary distributors and other special parts are to be positioned in easily-accessible areas and permanently protected from damage. Connection equipment approved by the pipe manufacturer is to be used to connect the lines to distributors and the like. The work is done exclusively with tools suitable for the connection equipment.



Fig. 42 | When dividing up pipelines, a sleeve is slipped onto the coupling with a press and then shielded. © Rehau

Only quality-assured materials are used as raw materials. >>

Both plastic and copper pipes with plastic sheathing can be used for component activation. The pipe system used is selected based on the technical requirements as well as the economic feasibility regarding investment and operating costs and should be chosen individually for each project.

After all installation and connection work on the lines (to the distributors, etc.), a leak test must be done for the heat supply system. If pressurised air is used for the test, a test pressure of 2.5 to 3 bar is recommended. When using water as a test medium, the test pressure should be increased from 4 to 6 bar. After two hours, check the pressure and adjust if necessary. The test duration is 12 hours. The system is leak-proof if liquid does not escape from any point in the pipelines and the test pressure does not fall more than 1.5 bar. The test and the test result must be logged.



Fig. 43 | top
 Pressurised air is applied
 to the heat supply system.
 © Aichinger Hoch- u. Tiefbau GmbH

Fig. 44 | bottom left and right
 The pressure test is done before,
 during and after concrete work.
 © Thomas Schönbichler/CL;
 © Aichinger Hoch- u. Tiefbau GmbH



In all areas in which hose movement could cause damage during installation or afterwards, suitable measures must be taken to protect the lines. In areas of feed-throughs and drainage and inlet lines of the pipes in concrete components, this can be ensured by installing protective sleeves, for example.

In order to protect the installed hoses from damage, the upper reinforcement layer must be installed as soon as possible after pipeline is installed.

Before beginning concrete work, pressure must be applied to the heat distribution system (the same amount as during the leak test performed during or after the installation work). The pressure in the pipelines must be continuously checked and maintained during the entire concrete work process. Any damages can be detected on-time and remedied before the concrete hardens.

Concrete work for activated components do not differ in principle from those of other components. There is also no difference regarding the quality of the installed concrete. It must only be ensured that the lines fastened with cable clips during work do not move from their original position. The installation of overly stiff concrete should also be prevented, as should the excessively fast emptying of buckets from tall heights. Carefully shaking the concrete completely encloses the pipelines with concrete. Good thermal conductivity is ensured with the inner contact. Great care must be taken when compressing the concrete in the area of the distributor (all heating circuits run together here). The surface of the raw ceiling is finalised as with all other reinforced steel ceilings.

The distribution beams on the ceiling soffit are to be positioned in the direction of the underlying rooms in activated ceiling areas with the TCA mechanism. When doing so, make sure that the distributor with the ventilation equipment is not positioned in the highest part of the hydraulic system. It must be ensured that unwanted accumulations of air are not created at the highest point of the system. Installing air separators is recommended in all cases.



Fig. 45 | top

Introduction and compression of the fresh concrete as well as the height control of the future upper ceiling edge.

© Aichinger Hoch- u. Tiefbau GmbH

Fig. 46 | right

A distribution beam arranged on the ceiling soffit for the overlying heating circuit.

© Aichinger Hoch- u. Tiefbau GmbH



Calculation example

A calculation for heat load must be done as a first step for every building. Due to the passive house standard of the building envelope, standard-compliant calculations for heat load are eliminated.

The calculation for heat load is done using the Passive House Planning Project (PHPP). To make the calculation steps clearer, the calculation for heat load according to the Passive House Planning Project (PHPP) is shown as a hand calculation.

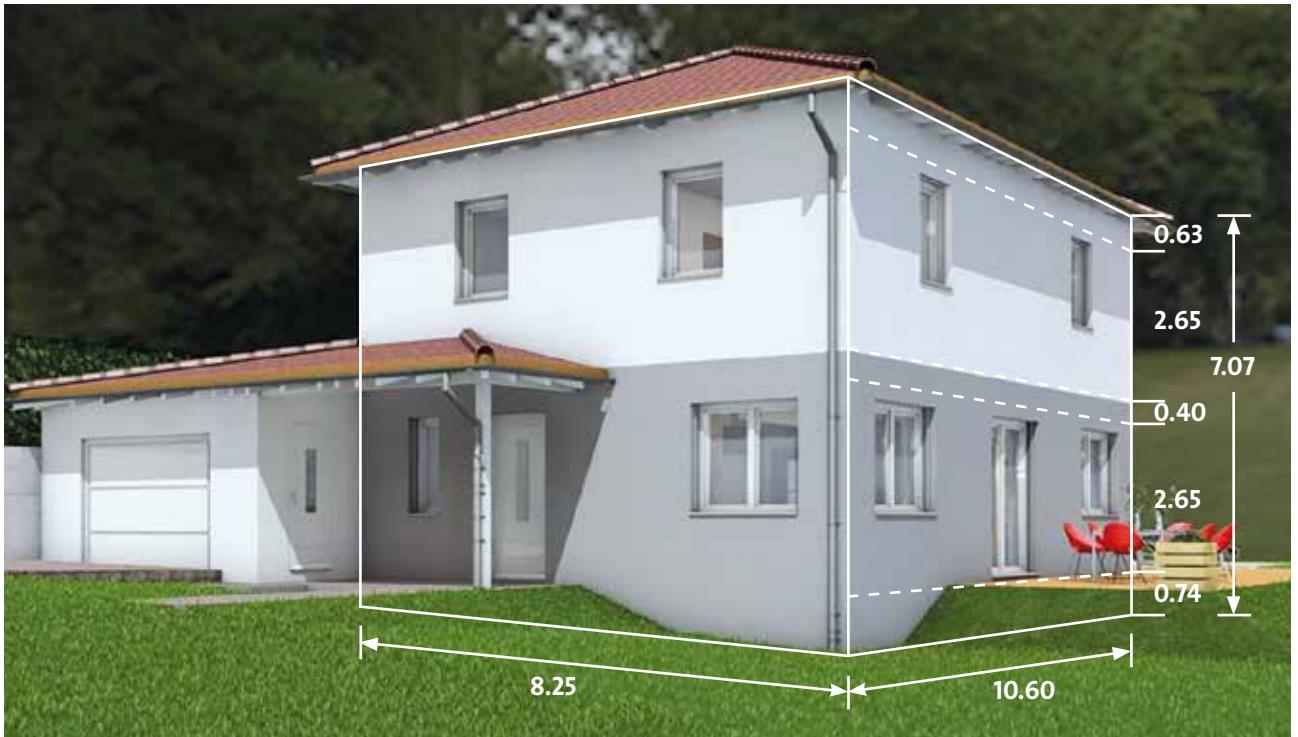

Fig. 47 | Rendering of the calculation example. © Aichinger Hoch- u. Tiefbau GmbH

Built-up area:	87.45 m ²
Gross base area (GBA):	$2 \cdot 87.45 = 174.90$ m ²
Gross height:	7.07 m
Gross volume:	618.30 m ³
Perimeter:	37.70 m
Façade surface:	266.54 m ²
Envelope area:	441.44 m ²
Living area (acc. to application plan):	123.75 m ²
Headroom height (GF and 1F):	2.65 m

Key building figures

- > The building does not have a cellar, consists of a ground and top storey and has the shape of a cuboid.
- > The base area of this cuboid (built-up area) has a surface area of $8.25 \cdot 10.60 = 87.45$ m².
- > The height of the cuboid results in $2 \cdot 2.65 + 0.63 + 0.40 + 0.74 = 7.07$ m.
- > The thickness of the upper storey ceiling of 0.63 m, the thickness of the intermediate ceiling of 0.40 m and the thickness of the foundation plate of

0.74 m is to be added to the headroom heights of the ground floor and top storey (2.65 m each) to get the gross height. According to the PHPP, the gross height from the upper edge of the upper storey ceiling to the lower edge of the insulation under the foundation plate must be measured; the granular subbase and the aggregate layer are not included in the calculation.

Component list (outside components)

All components of the building envelope are in the component list. The layer structures for the U-value calculation are taken from the energy certificate.

		U value [Wm ⁻² K ⁻¹]
Upper ceiling	22 cm STB plate / 40 cm EPS W2o Plus	0.08
Exterior wall	52 cm twin-shell, core-insulated, plastered foamed clay wall	0.10
Foundation plate	Floor structure / 25 cm STB plate / 30 cm insulation*	0.08**
Window	Triple heat protection glass with passive house frame	0.69
French doors	Triple heat protection glass with passive house frame	0.65
Entry door	Passive house door	0.80

*The insulation thickness of 30 cm was selected to comply with the requirement for implementation with the passive house standard.

**With the specified U-value, the thermal resistance for the heat throughput through the soil in accordance with ÖNORM EN ISO 13370 has already been taken into account.

Surface calculation for the outside components

The area is calculated for all components of the building envelope using the outside dimensions. The foundation of this calculation is the application plan.

The shell dimensions of the window openings are set for the **door and window areas**. Since the solar energy input is taken into account in the calculation for heat load in accordance with PHPP, the window and door openings are to be surveyed in line with the façade orientation.

Façade	Window or door area [m ²]	
SE	1.44	2 Window (W)
SE	6.58	4 Window (W)
SE	2.33	1 French door (FD)
SW	8.01	4 Window (W)
SW	4.19	1 French door (FD)
NW	6.01	4 Window (W)
NW	2.70	Entry door (ED)
	31.26	Total areas of windows and doors

The following (gross) areas are the result for the **components of the building envelope**:

	Area [m ²]
Upper ceiling	87.45
Exterior wall	235.28
Foundation plate	87.45
Window (W)	22.04
French door (FD)	6.52
Entry door (ED)	2.70
Envelope area	441.44

Calculation of the thermal transmission conductance | L_e L_b

The partial thermal conductance values are to be calculated as the product of the U-value and associated component areas and added up, whereby a differentiation has to be made between the components exposed to air and those exposed to soil.

$$\text{Area [m}^2\text{]} \cdot \text{U-value [Wm}^{-2}\text{K}^{-1}\text{]} = \text{thermal conductance [WK}^{-1}\text{]}$$

a) Components exposed to air:

	Area [m ²]	U value [Wm ⁻² K ⁻¹]	Thermal conductance [WK ⁻¹]
Upper ceiling	87.45	0.08	6.996
Exterior wall	235.28	0.10	23.528
Window	22.04	0.69	15.208
French doors	6.52	0.65	4.238
Entry door	2.70	0.80	2.160
L_e components exposed to air			52.130

L_e
Thermal conductance of the components exposed to air

L_b
Thermal conductance of the components exposed to soil

b) Components exposed to soil:

	Area [m ²]	U value [Wm ⁻² K ⁻¹]	Thermal conductance [WK ⁻¹]
Foundation plate	87.45	0.08	6.996
L_b components exposed to soil			6.996

Due to the requirements on the detailed planning of the component connections of passive house envelopes, according to which the effect of thermal bridges on the total thermal conductance must be small enough that the entire thermal conductance factor must be zero or negative, no thermal bridge correction factor can be invoiced for passive houses. A thermal bridge certificate is submitted for the building which results in a negative factor (-2,0 WK⁻¹). By zeroing this factor, a certain amount of security is introduced into the estimated calculation for heat load.

Calculation for heat load according to the PHPP for the entire house

According to the PHPP, the heat load is calculated both for a cooler day with high solar radiation and for a warmer but cloudy day. The higher value is considered the heat load.



Climate data for the calculation for heat load

The climate data for the calculation for heat load are taken from PHPP for the Stockerau site as follows:

- Climate 1** | Clear, cold day
- Climate 2** | Warmer, cloudy day

	Climate 1	Climate 2
Outside air temperature	-9.0 °C	-7.4 °C
Soil temperature	7.5 °C	7.5 °C
Irradiation intensity, NE	12 Wm ⁻²	11 Wm ⁻²
Irradiation intensity, SE	51 Wm ⁻²	19 Wm ⁻²
Irradiation intensity, SW	51 Wm ⁻²	19 Wm ⁻²
Irradiation intensity, NW	12 Wm ⁻²	11 Wm ⁻²

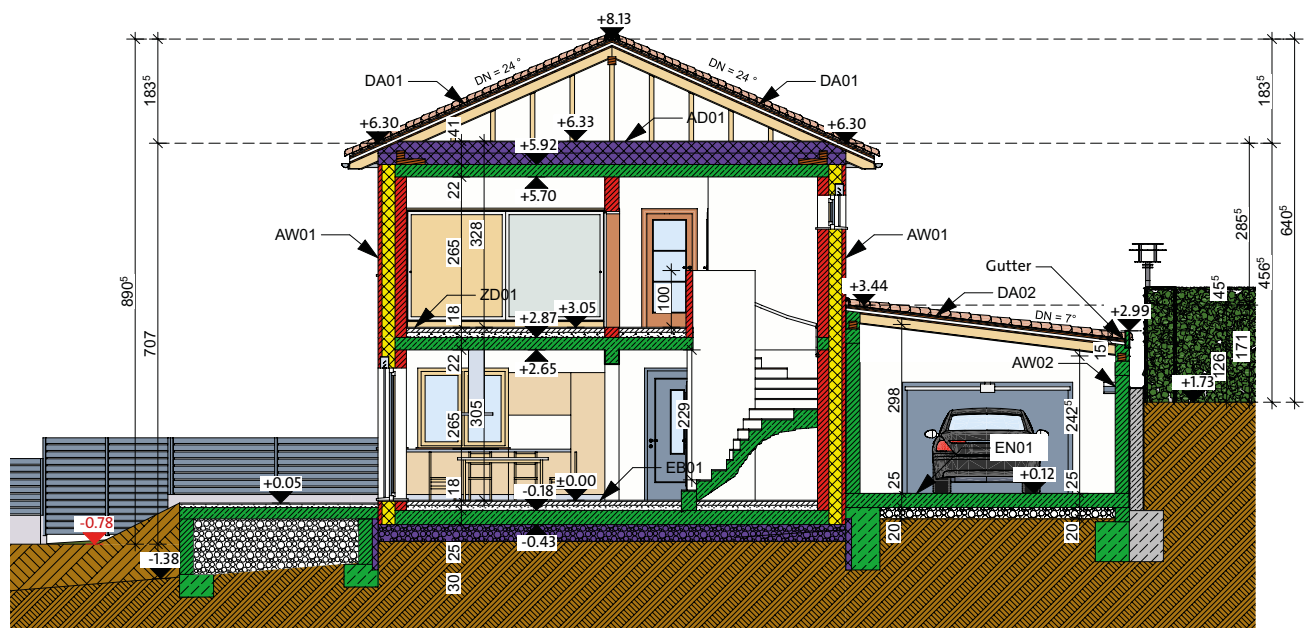

Fig. 48 | Cross-section of the house draft of the calculation example.

© Aichinger Hoch- u. Tiefbau GmbH

1. Calculation of transmission heat losses | Φ_T

a) The **heat losses through the foundation plate** are independent of the climatic assumptions according to the PHPP and result in

$$\Phi_b = L_b \text{ components exposed to soil} \cdot (\text{set temperature} - \text{soil temperature})$$

$$\Phi_b = 6.996 \cdot (20 - 7.5) = \mathbf{87.5 \text{ W}}$$

The set temperature in the building is adopted according to the standard at 20 °C.

b) The **heat losses through the components exposed to air** for the clear, cold day (**climate 1**) result in

$$\Phi_e = L_e \text{ components exposed to air} \cdot (\text{set temperature} - \text{outside temperature})$$

$$\Phi_e = 52.13 \cdot (20 - (-9)) = \mathbf{1511.77 \text{ W}}$$

For the cloudy winter day (**climate 2**), they are somewhat smaller:

$$\Phi_e = 52.13 \cdot (20 - (-7.4)) = \mathbf{1428.36 \text{ W}}$$

c) Total transmission heat loss | Φ_T

The transmission heat losses of the building result from the sum of the heat losses of the components exposed to soil and the heat losses of the components exposed to air as:

$$\Phi_T = \Phi_b + \Phi_e = 87.5 + 1511.77 = 1599.3 \text{ W (climate 1)}$$

$$= 87.5 + 1428.36 = 1515.9 \text{ W (climate 2)}$$

The transmission heat losses are as follows:

Climate 1 | 1599.3 W

Climate 2 | 1515.9 W

Φ_b
Heat losses via
components exposed to soil

Φ_e
Heat losses via
components exposed to air

Φ_T
Total heat loss

2. Calculation of ventilation heat loss | Φ_V

The building is equipped with a ventilation system with heat recovery. According to the energy certificate, the heat supply efficiency of the system can set at at least 80% ($\eta_{WRG} = 0.8$).

For the fresh air supply required for hygienic reasons, the minimum value according to the PHPP is set with a 0.3-time air change rate ($n_L = 0.3 \text{ h}^{-1}$). An air change, which sets in due to leaks in the building envelope (infiltration), supersedes the hygienic ventilation system. According to the PHPP, the air change rate for infiltration in the case of calculation for heat load is to be set to $n_X = 0.12 \text{ h}^{-1}$ if $n_{S0} = 0.6 \text{ h}^{-1}$ was verified with the blower door test.

a) Room volume

The **volume** relevant for the air change is a result of the product of the **living area and headroom height** of

$$V = \text{living area} \cdot \text{headroom height} = 123.75 \cdot 2.65 = 327.94 \text{ m}^3.$$

b) Thermal ventilation conductance

When calculating the **thermal ventilation conductance**, it must be considered that only the heat losses due to the required hygienic ventilation by heat recovery of the ventilation system are reduced. Losses due to infiltration, on the other hand, account for 100%. The thermal ventilation conductance is therefore calculated as

$$L_V = 0.34 \cdot V \cdot [(n_L \cdot (1 - \eta_{WRG}) + n_X)] = 0.34 \cdot 327.94 \cdot [(0.3 \cdot (1 - 0.8) + 0.12)] = 20.07 \text{ WK}^{-1}.$$

The factor 0.34 is the volume-related thermal capacity of the air in $\text{Whm}^{-3}\text{K}^{-1}$.

c) Ventilation heat loss

The ventilation heat losses result in

$$\begin{aligned} \Phi_V &= L_V \cdot (\Theta_i - \Theta_e) = 20.07 \cdot (20 - (-9)) = 20.07 \cdot 29 = 582.0 \text{ W (Climate 1)} \\ &= 20.07 \cdot (20 - (-7.4)) = 20.07 \cdot 27.4 = 549.9 \text{ W (Climate 2)}. \end{aligned}$$

Climate 1 | 582.0 W

Climate 2 | 549.9 W

Φ_V

Ventilation heat loss

η_{WRG}

Heat supply efficiency

n_L

Air change rate

n_X

Air change rate for infiltration

V

Room volume

L_V

Thermal ventilation conductance

Θ_i

Set temperature of the room

Θ_e

Outside air temperature

3. Calculation of total heat loss | Φ_l

The heat losses of the building under design conditions are the result of the sum of the transmission and ventilation heat loss of

$$\Phi_l = \Phi_T \text{ transmission heat loss} + \Phi_V \text{ ventilation heat loss}$$

$$\begin{aligned} \Phi_l &= \Phi_T + \Phi_V = 1599.3 + 582.0 = 2181.3 \text{ W} \quad (\text{Climate 1}) \\ &= 1515.9 + 549.9 = 2065.8 \text{ W} \quad (\text{Climate 2}) \end{aligned}$$

Climate 1 | 2181.3 W

Climate 2 | 2065.8 W

 Φ_l

Total heat loss

 Φ_T

Transmission heat loss

 Φ_V

Ventilation heat loss

4. Calculation of heat input | Φ_g

Heat gains inside the building set in due to building use and sun radiation through the windows. In contrast to the standard-compliant calculation for heat load, the effect of the heat recovery is not ignored here.

a) Occupancy sensible gain | Φ_i

A heat output by living area of 1,9 W/m² is set (according to PHPP). This includes all heat outputs caused by occupancy, lighting and the operation of devices.

The usage-dependent heat output results in

$$\begin{aligned} \Phi_i &= 1.9 \cdot \text{living space} \\ \Phi_i &= 1.9 \cdot 123.75 = \mathbf{235.1 \text{ W}} \end{aligned}$$

b) Heat gain due to sun radiation | Φ_s

For the clear, cold day, the heat input based on sun radiation through the transparent parts of the building envelope are calculated as follows:

$$\Phi_s = A_w \cdot g \cdot r \cdot I$$

	A_w [m ²]	g	r	I [Wm ⁻²]	Heat input [W]
Window, NE	1.44	0.51	0.27	12.0	2.38
Window, SE	6.58	0.51	0.39	51.0	66.75
French door, SE	2.33	0.51	0.41	51.0	24.85
Window, SW	8.01	0.51	0.40	51.0	83.34
French door, SW	4.19	0.51	0.44	51.0	47.95
Window, NW	6.01	0.51	0.37	12.0	13.61

Climate 1 $\Phi_s = 238.88$

 Φ_g

Total heat gain

 Φ_i

Occupancy
sensible gain

 Φ_s

Solar gain

 A_w

Area of the windows and
glazed doors (including frame)

 g

Solar heat gain coefficient
("g value") of the glass

 r

Reduction factor

 I

Solar irradiation intensity

NOTE:

The differences in the reduction factors are the result of the different percentages of glass for the various windows.

The calculation for the cloudy day only differs due to the solar irradiation intensity and leads to the following result:

	A_w [m ²]	g	r	I [Wm ⁻²]	Heat input [W]
Window, NE	1.44	0.51	0.27	11.0	2.18
Window, SE	6.58	0.51	0.39	19.0	24.87
French door, SE	2.33	0.51	0.41	19.0	9.26
Window, SW	8.01	0.51	0.40	19.0	31.05
French door, SW	4.19	0.51	0.44	19.0	17.86
Window, NW	6.01	0.51	0.37	11.0	12.48

Climate 2 $\Phi_S = 97.70$

- A_w
Area of the windows and glazed doors (including frame)
- g
Solar heat gain coefficient ("g value") of the glass
- r
Reduction factor
- I
Solar irradiation intensity

c) Total heat input | Φ_g

$$\begin{aligned} \Phi_g &= \Phi_i + \Phi_S = 235.1 + 238.88 = 474.0 \text{ W (Climate 1)} \\ &= 235.1 + 97.70 = 332.8 \text{ W (Climate 2)} \end{aligned}$$

- Φ_g
Total heat gain
- Φ_i
Occupancy sensible gain
- Φ_S
Solar gain

The heat recovery occurring inside the building under design conditions are the result of the sum of the use-related and solar heat recovery as follows:

Climate 1 | 474.0 W
Climate 2 | 332.8 W

5. Calculation of total heat load | $\Phi_{HL,Geb}$

The total heat load is the difference of the heat loss and heat input rate and is calculated for both outside climactic assumptions:

$$\Phi_l \text{ heat lost rate} - \Phi_g \text{ heat input rate} = \text{total heat load}$$

	Heat losses [W]	Heat losses [W]	Heat load [W]
Climate 1	2181.3	474.0	1707.3
Climate 2	2065.8	332.8	1733.0

It has been shown that the heat load for both assumptions is nearly as large with regard to the outdoor climactic conditions for the building in question. The larger value – meaning **1733 W** – is to be taken as the heat load.

Referring to the living space, a value of

$$\frac{1733}{123.75} = \mathbf{14.0 \text{ Wm}^{-2}}$$

results which is significantly below the upper limit of **25 Wm⁻²**.

As the result of the total heat load calculation, it turns out that the building is optimally suited for sole heating by means of thermally-activated storey ceilings.

Calculation for heat load according to the PHPP for the combined kitchen/living room

When doing the design calculations, the calculation for heat load must be repeated for every room of the heated part of the building. Such a calculation process should be outlined as an example for the combined kitchen/living room on the ground floor. The highest heat load by treated floor area is to be expected for this room because the percentage of windows is the highest in comparison to the other rooms.



The calculation for heat load is only done for the cloudy day, climate 2.

Gross area:	$10.6 \cdot 4.125 = 43.73 \text{ m}^2$
Gross height:	$0.74 + 2.65 + 0.20 = 3.59 \text{ m}$
Façade surface:	67.67 m^2
Living area (acc. to application plan):	34.23 m^2
Headroom height:	2.65 m

**Key combines kitchen/
living room figures**

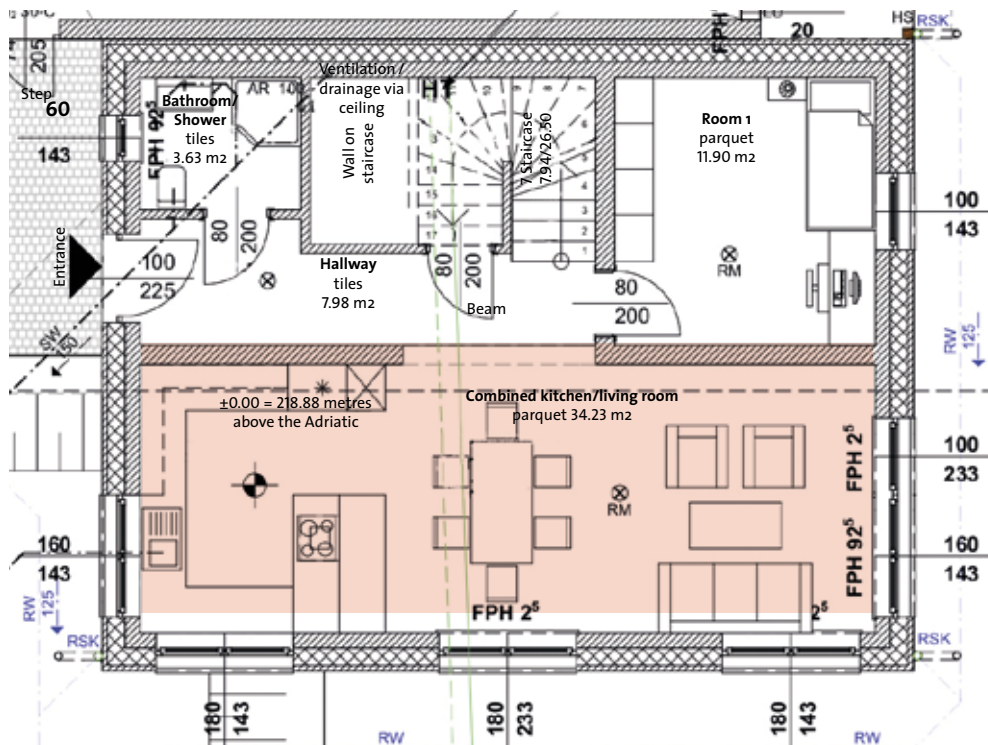

Fig. 49 | Ground floor site plan of the calculation example. © Aichinger Hoch- u. Tiefbau GmbH

Surface calculation for the outside components

Window and door areas:

Façade	Window or door area [m ²]	
SE	2.29	1 Window (W)
SE	2.33	1 French door (FD)
SW	5.15	2 Window (W)
SW	4.19	1 French door (FD)
NW	2.29	1 Window (W)
	16.25	Total areas of windows and doors

The following (gross) areas are the result for the **components of the combined kitchen/living room**:

	Area [m ²]
Exterior wall	51.42
Foundation plate	43.73
Window (W)	9.73
French door (FD)	6.52

Calculation of the thermal transmission conductance | L_e L_b

a) Components exposed to air:

	Area [m ²]	U value [Wm ⁻² K ⁻¹]	Thermal conductance [WK ⁻¹]
Exterior wall	51.42	0.10	5.142
Window (W)	9.73	0.69	6.714
French doors (FD)	6.52	0.65	4.238

L_e components exposed to air **16.094**

b) Components exposed to soil:

	Area [m ²]	U value [Wm ⁻² K ⁻¹]	Thermal conductance [WK ⁻¹]
Foundation plate	43.73	0.08	3.498

L_b components exposed to ground **3.498**

1. Calculation of transmission heat losses | Φ_b Φ_e

a) Foundation plate:

$\Phi_b = L_b$ components exposed to soil · (set temperature – soil temperature)

$$\Phi_b = 3.498 \cdot (20 - 7.5) = \mathbf{43.7 \text{ W}}$$

b) Components exposed to air:

$\Phi_e = L_e$ components exposed to air · (set temperature – outside temperature)

$$\Phi_e = 16.094 \cdot (20 - (-7.4)) = \mathbf{441.0 \text{ W}}$$

2. Calculation of ventilation heat loss | Φ_V

a) Room volume:

$$V = \text{living area} \cdot \text{headroom height} = 34.23 \cdot 2.65 = \mathbf{90.71 \text{ m}^3}$$

b) Thermal ventilation conductance:

$$L_V = 0.34 \cdot V \cdot [(\mathbf{n}_L \cdot (1 - \eta_{WRG}) + \mathbf{n}_X)] =$$

$$0.34 \cdot 90.71 \cdot [(0.3 \cdot (1 - 0.8) + 0.12)] = \mathbf{5.55 \text{ WK}^{-1}}$$

c) Ventilation heat loss

$$\Phi_V = L_V \cdot (\Theta_i - \Theta_e) = 5.55 \cdot 27.4 = \mathbf{152.1 \text{ W}}$$

3. Calculation of total heat loss | Φ_I

$\Phi_I =$ transmission heat loss + ventilation heat loss

$$\Phi_I = \Phi_b + \Phi_e + \Phi_V = 43.7 + 441.0 + 152.1 = \mathbf{636.8 \text{ W}}$$

4. Calculation of heat input in the room | Φ_g

a) Occupancy sensible gain | Φ_i

$$\Phi_i = 1.9 \cdot \text{living space}$$

$$\Phi_i = 1.9 \cdot 34.23 = \mathbf{65.0 \text{ W}}$$

b) Heat gain due to sun radiation | Φ_S

$$\Phi_S = A_W \cdot g \cdot r \cdot I$$

	A_W [m ²]	g	r	I [Wm ⁻²]	Heat input [W]	
A_W Area of the windows and glazed doors (including frame)	Window, SE	2.29	0.51	0.39	19.0	8.65
	French door, SE	2.33	0.51	0.41	19.0	9.26
g Solar heat gain coefficient ("g value") of the glass	Window, SW	5.15	0.51	0.40	19.0	19.96
	French door, SW	4.19	0.51	0.44	19.0	17.86
r Reduction factor	Window, NW	2.29	0.51	0.37	11.0	4.75
I Solar irradiation intensity						$\Phi_S = \mathbf{60.48}$

c) Total heat input | Φ_g

$$\Phi_g = \Phi_i + \Phi_S = 65 + 60.48 = \mathbf{125.5 \text{ W}}$$

5. Calculation of heat load of considered space | Φ_{HL}

The heat load is the result of the difference between heat losses and heat input:

$$\Phi_{HL} = \Phi_l - \Phi_g = 636.8 - 125.5 = \mathbf{511 \text{ W}}$$

Referring to the living space, a value of

$$\frac{511}{34.23} = \mathbf{14.9 \text{ Wm}^{-2}}$$

which is somewhat above the total heat load, but still significantly below the upper limit of 25 Wm⁻².

Φ_{HL}
Heat load of considered space

Φ_l
Heat loss

Φ_g
Heat recovery

Design of the effective heat exchanger surface

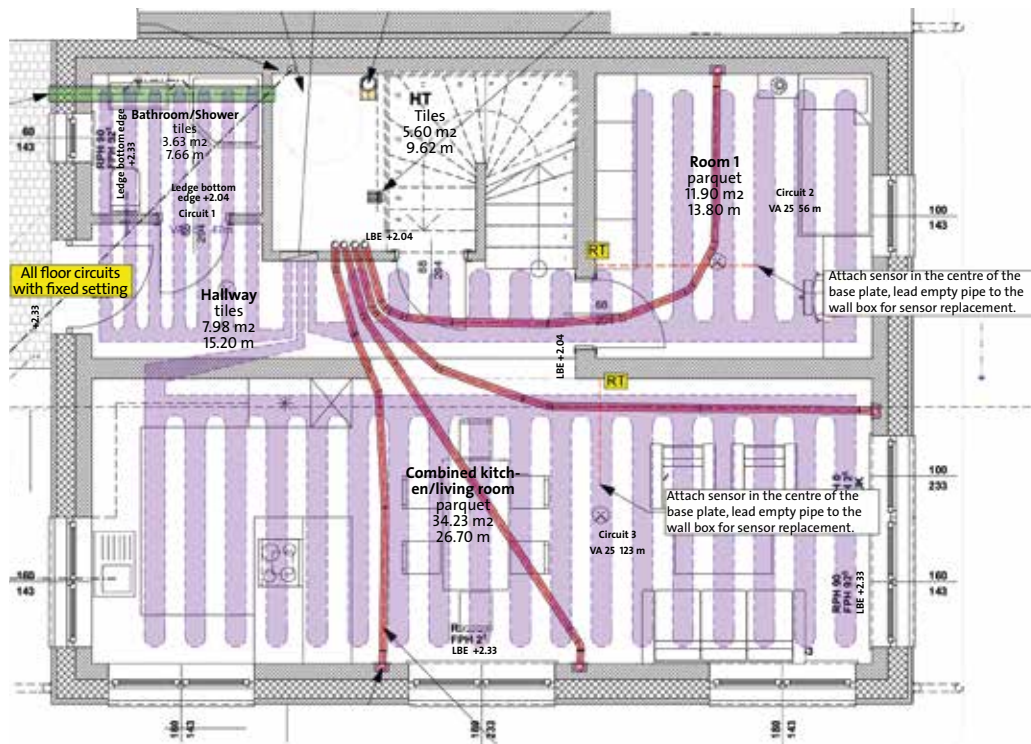

Fig. 50 | Installation plan of the pipe register in the ground floor storey ceiling.

© FIN – Future Is Now, Kuster Energielösungen GmbH

The pipes of the register are installed with an installation distance of 25 cm. The distance of the pipe register from the ceiling soffit corresponds to 5 cm of the thickness of the concrete hallway.

The thermal conductance by treated floor area between the pipe register and the combined kitchen/living room are calculated using the parameters from Table 3 (page 76):

$$\Lambda_{ru} = a \cdot d^2 + b \cdot d + c = 4.53 \cdot 0.25^2 - 8.04 \cdot 0.25 + 5.7 = \mathbf{4.0 \text{ Wm}^{-2}\text{K}^{-1}}$$

When the temperature difference is assumed to be $\Delta\Theta = 5.0 \text{ K}$ between the temperature of the heating medium and the set temperature in the combined kitchen/living room, the required effective heat exchanger surface results in

$$A_R = \frac{\Phi_{HL}}{q} = \frac{\Phi_{HL}}{\Lambda_{ru} \cdot \Delta\Theta} = \frac{511}{4.0 \cdot 5.0} = \mathbf{25.6 \text{ m}^2}$$

Λ_{ru}
Thermal conductance by treated floor area (TFA)

d
Axial spacing of the pipes

Φ_{HL}
Heat load of considered space

q
Heat output by treated floor area (TFA)

$\Delta\Theta$
Temperature difference

A pipe register with about 28 m² of space was installed. The edge areas of the storey ceiling and the area above the kitchenette were not thermally activated. The effect of thermal activation is reduced due to the decreased radiant heat transfer in the area directly next to the edges between the wall and the ceiling. The thermal activation would be nearly ineffective over the wall fitting of the kitchenette.

Under design conditions, the surface temperature in the assumed situation according to equation (5) (see page 77) is

$$\frac{q}{\alpha} = \frac{\Lambda_{ru} \cdot \Delta\Theta}{\alpha} = \frac{4.0 \cdot 5.0}{6.5} = \mathbf{3.1\text{ K}}$$

above the set temperature in the room.

This ensures a high level of comfort. The very low temperatures of the heating medium also ensure high operating efficiency of the heat pump.

List of figures & tables / Bibliography

List of figures

- Fig. 1** | During component activation, a system of water-conducting pipelines is laid into concrete components. This is perfectly easy to accomplish.
© Aichinger Hoch- u. Tiefbau GmbH
- Fig. 2** | Schematic diagram of component activation of a storey ceiling.
© Z + B
- Fig. 3** | The installation of heating and cooling registers into the ceiling can be done quickly, easily and therefore economically.
© Aichinger Hoch- u. Tiefbau GmbH
- Fig. 4** | Schematic diagram of heat radiation: Every point of the activated ceiling (and also of the other components enveloping the room) radiates heat in a semi-spherical shape, just as is shown using the randomly selected points in the graphic.
© Z + B
- Fig. 5** | Vertical section through a sample room with isotherms during heating/winter operation with an activated ceiling. Noticeable is the uniform temperature distribution and the small temperature differences in the room.
© Z + B
- Fig. 6** | Comfort range of surface temperature to air temperature.
Source: www.thermische-behaglichkeit.de/thermische-behaglichkeit.
The comfort criteria are easy to uphold with TCA.
© Z + B
- Fig. 7** | Renewable energy, such as wind power (© W.E.B-Windkraftanlage/eric krügl) and solar power through a photovoltaic system (© F. Huber) or a thermal solar plant (© GASOKOL) are predestined for use by means of TCA.
- Fig. 8** | Calculated in the course of a day, the average surface temperature at the ceiling soffit for heat supply restricted between 10⁰⁰ pm and 6⁰⁰ am (use of off-peak electricity); set temperature of the room: 22 °C.
© Klaus Kreč
- Fig. 9** | Absorption of the heat output by treated floor area of a thermally-activated ceiling after switching off the circulation pump.
© Klaus Kreč
- Fig. 10** | Measurement equipment for the blower door test.
© VÖZ
- Fig. 11** | Energy harvest from wind energy. Output progression over the period of a year.
(Source of data: [WEB15])
- Fig. 12** | Application examples of photovoltaic modules for electricity generation.
Griffen © Energetica Industries GmbH; Dünnschicht Module © Prefa
- Fig. 13** | Solar thermal energy system of the Saalfelden climbing gym and a Hörfarter office building.
© Z + B/Wild & Team; © Wolfgang Hörfarter/Hans Osterauer

- Fig. 14 | 1** *Charging of the storage system with heat from environmental energy. Heat generated from different energy sources can be stored within the building.*
© Simon Handler
- Fig. 14 | 2** *Covering heat losses with stored energy (no environmental energy can be used). If no external heat source is available, the stored heat is used to cover heat losses of the building.*
© Simon Handler
- Fig. 14 | 3** *Feed-in of energy generated on-site into public grids (Storage medium completed charged). If there are no heating needs or no option for additional heat storage in the building, the energy generated can be fed into (public) grids.*
© Simon Handler
- Fig. 14 | 4** *Obtaining energy from public grids (no environmental energy can be used). If the "building" heat accumulator is exhausted and no environmental energy is available, the building is supplied from the existing grids until it is again possible to supply with heat or electrical energy from "environmental energy".*
© Simon Handler
- Fig. 14 | 5** *Passive cooling (operation of a circulation pump). The energy needs for the drive of the circulation pumps is minimal for free cooling operation.*
© Simon Handler
- Fig. 14 | 6** *Use of environmental energy for active cooling via a reversible heat pump. The drive energy for the heat pump primarily comes from renewable energy sources (PV system, wind power).*
© Simon Handler
- Fig. 15** | *Basic principle of the control strategy for storing thermal energy from environmental energies inside the building structure.*
© Simon Handler
- Fig. 16** | *Dependency of efficiency of heat pumps and solar collectors as a function of system temperatures.*
© Simon Handler
- Fig. 17** | *Heating circuits laid in the ceiling of a single-family house in Lower Austria.*
© Thomas Schönbichler/CL
- Fig. 18** | *Example for system variant 1 – Energy supply via solar thermal energy Hallwang community centre*
© Adrian Kuster, Millstatt
- Fig. 19** | *Schematic sketch for system variant 1 – Energy supply via solar thermal energy.*
© Simon Handler
- Fig. 20** | *Example for system variant 2 – PV-heat pump-component activation, Elsbethen Austraße multiple-family houses, Salzburg.*
© Michael Harrer
- Fig. 21** | *Schematic sketch for system variant 2 – PV-heat pump-component activation.*
© Simon Handler
- Fig. 22** | *Example for system variant 3 – wind-heat pump-component activation, single-family house in Lower Austria*
© Aichinger Hoch- u. Tiefbau GmbH

- Fig. 23** | Schematic sketch for system variant 3 – Energy supply via wind energy and heat pump.
© Simon Handler
- Fig. 24** | The power house with heat pump, hot water boiler, circulation pump and distribution lines, etc. is assembled clearly in the smallest possible space.
© FIN – Future Is Now, Kuster Energielösungen GmbH
- Fig. 25** | Comfort range of surface temperature to air temperature.
Source: www.thermische-behaglichkeit.de/thermische-behaglichkeit. The comfort criteria are easy to uphold with TCA.
© Z + B
- Fig. 26** | Installation of a temperature sensor in the area of the heat register to measure the core temperature.
© Aichinger Hoch- u. Tiefbau GmbH
- Fig. 27** | Pipe diameter, pipe length and thereby flow resistance are criteria for dimensioning the circulation pump.
© FIN – Future Is Now, Kuster Energielösungen GmbH
- Fig. 28** | Simulation room at Innovations- und Forschungsstelle Bau, Salzburg, Austria: Temperature and output drawings in the research period.
After switching off the heating, the operative temperature falls only minimally.
© ARGE Nachhaltige BAUTEILAktivierung
- Fig. 29** | Simulation room at Innovations- und Forschungsstelle Bau, Salzburg, Austria: Temperature and output drawings in the research period. Despite switching off the cooling on 2. 8. 2013, the operative temperature does not rise rapidly.
© ARGE Nachhaltige BAUTEILAktivierung
- Fig. 30** | 3D representation of the model room
© Z + B
- Fig. 31** | Dependency of the thermal conductance by treated floor area $\Lambda_{r,u}$ on the axial spacing of the pipes.
© Klaus Kreč
- Fig. 32** | Design suggestion for open cellar, insulation with passive house standard, EPS insulating material with $\lambda = 0.031 \text{ W/mK}$, insulation on the ceiling soffit 20 cm.
© Z + B
- Fig. 33** | Design suggestion for closed cellar, insulation with passive house standard, EPS insulating material with $\lambda = 0.031 \text{ W/mK}$, insulation on the ceiling soffit 10 cm. © Z + B
- Fig. 34** | The ceiling to be activated is overlaid in accordance with an installation diagram, typically on the lowest reinforcement layer or, for construction reasons, on a light construction steel mesh mat directly on the prefabricated ceiling.
© Aichinger Hoch- u. Tiefbau GmbH
- Fig. 35** | Diagram of the temperature distribution and heat flow lines; ceiling structure; heating: temperature of heating medium 28 °C; room air temperature 20 °C.
© Klaus Kreč

- Fig. 36** | *Model house schematic diagram, diagram – heating, draft.*
© FIN – Future Is Now, Kuster Energielösungen GmbH
- Fig. 37** | *Application examples of ground collectors.*
© FIN – Future Is Now, Kuster Energielösungen GmbH
- Fig. 38** | *The installation distances chosen in wet rooms are smaller than in the living area.*
© Aichinger Hoch- u. Tiefbau GmbH
- Fig. 39** | *The temperature sensor is installed at the level of the pipe register.*
© Aichinger Hoch- u. Tiefbau GmbH
- Fig. 40** | *Implementation of the in-situ concrete ceiling: The pipelines are typically mounted in the lowest reinforcement layer.*
© Thomas Schönbichler/CL
- Fig. 41** | *Implementation of the prefabricated ceiling: The pipelines are fastened directly on the prefabricated ceiling on a construction steel grate.*
© Aichinger Hoch- u. Tiefbau GmbH
- Fig. 42** | *When dividing up pipelines, a sleeve is slipped onto the coupling with a press and then shielded.*
© Rehau
- Fig. 43** | *Pressurised air is applied to the heat supply system.*
© Aichinger Hoch- u. Tiefbau GmbH
- Fig. 44** | *The pressure test is done before, during and after concrete work.*
© Thomas Schönbichler/CL; © Aichinger Hoch- u. Tiefbau GmbH
- Fig. 45** | *Introduction and compression of the fresh concrete as well as the height control of the future upper ceiling edge.*
© Aichinger Hoch- u. Tiefbau GmbH
- Fig. 46** | *A distribution beam arranged on the ceiling soffit for the overlying heating circuit.*
© Aichinger Hoch- u. Tiefbau GmbH
- Fig. 47** | *Rendering of the calculation example.*
© Aichinger Hoch- u. Tiefbau GmbH
- Fig. 48** | *Cross-section of the house draft of the calculation example.*
© Aichinger Hoch- u. Tiefbau GmbH
- Fig. 49** | *Ground floor site plan of the calculation example.*
© Aichinger Hoch- u. Tiefbau GmbH
- Fig. 50** | *Installation plan of the pipe register in the ground floor storey ceiling.*
© FIN – Future Is Now, Kuster Energielösungen GmbH

- Table 1** | Growth of power consumption for air conditioners and fans in Vienna
(Source: EEG calculations (TU Wien); Energy Report of the City of Vienna 2014)
- Table 2** | Designations from the Greek alphabet common in building physics and in the standards.
- Table 3** | Coefficients in equation (6) for calculating $\Lambda_{r,u}$.
Pipe 17 x 2 mm; concrete cover 5 cm; exposed ceiling soffit

List of tables

Ecker Johann, Friembichler Felix, Huber Frank, Klaus Kreč :

Wissensbasis Energiespeicher Beton, Wissensbasis für den Praktiker.

Betonmarketing Österreich, Wien, Auflage 2, 2014

Klaus Kreč :

Forschungsprojekt Energiespeicher Beton Endbericht.

Vereinigung der Österreichischen Zementindustrie, Wien, 2016

www.zement.at/services/publikationen/energiespeicher-beton

Handler Simon:

Konditionierung von massiven Einfamilienhäusern mit Wärmepumpe unter Nutzung der Leistungsspitzen im öffentlichen Stromnetz.

Zement + Beton Handels- und Werbeges.m.b.H., Wien, 2015

OIB-Richtlinie 6, NAT Excel: EXCEL-Tool zur Berechnung der Normaußentemperatur.

<http://www.oib.or.at/en/node/150030>, Wien, September 2008

Austrian Standards:

Hygienerrelevante Planung, Ausführung, Betrieb, Überwachung und Sanierung von zentralen Trinkwasser-Erwärmungsanlagen, ÖNORM B 5019: 2011 05 01.

https://shop.austrian-standards.at/action/de/public/details/390214/OENORM_B_5019_2011_05_01

OENORM_B_5019_2011_05_01

Bibliography

Legal information

Media owner & editor	Bundesministerium für Verkehr, Innovation und Technologie Radetzkystraße 2, 1030 Wien Abteilung für Energie- und Umwelttechnologien www.nachhaltigwirtschaften.at
Manufacturer	Zement + Beton Handels- u. Werbeges.m.b.H Franz Grill Straße 9, 1030 Wien www.zement.at
Manufacture & publishing place	Wien
Project initiative & project management	Felix Friembichler, VÖZ
Editing	Felix Friembichler, VÖZ Frank Huber, Zement + Beton
Authors	Felix Friembichler, VÖZ Simon Handler, hbo-Service GmbH Klaus Kreč, Büro für Bauphysik Harald Kuster, Kuster Energielösungen GmbH
Project partners	WEB Windenergie AG: Provision of data from wind-generated electricity
Proofreading	Cathérine Stuzka, Zement + Beton
Layout	Susanne Teschner, Zement + Beton
Image material	With the kind support of Aichinger Hoch- und Tiefbau GmbH and courtesy of the house owners.
Translation	itl Institut für technische Literatur GmbH Lerchenfelder Gürtel 43, 1160 Wien.
Printing	Samson Druck, 5581 St. Margarethen 171

1st german edition, June 2016
1st english edition, February 2017

All information in this planning guide is given with no liability assumed although the greatest possible care was given during treatment and monitoring of the content. Liability of the authors as well as the media owner and publisher for the content of this work, particularly concerning the correctness and applicability of the concrete application examples, is excluded.

Disclaimer

For better legibility, the masculine form is used for gender-specific terms and gender-suitable formulations are omitted. This is in no way meant to express gender discrimination or a violation of the principle of equality.

The findings of this project should also be used for training. That is why authors and copyright holders of figures and photos agree to the use of texts and image material for training purposes under the Creative Commons License by-nc-sa (i.e. attribution - non-commercial - share alike 4.0 International).



A project report
in the framework of the program



on behalf of the Federal Ministry
for Transport, Innovation and Technology



